

**Frigoduman**<sup>®</sup>



Fiyat Listesi **2024**

- Listedeki fiyatlar KDV hariç fiyatlardır.
- Fiyatlar mağazamız teslimidir. Nakliye ve sigorta alıcıya aittir.
- Vergi ve fonlarda olabilecek değişiklikler, fiyatlarımıza aynen yansıtılacaktır.
- Şirketimiz, önceden haber vermeksizin fiyatları değiştirme hakkına sahiptir.
- Döviz kuru, aşağıda çalıştığımız bankaların döviz satış kuru üzerinden hesaplanır.

## BANKA HESAP NUMARALARIMIZ

İZMİR		
Banka Adı	Hesap Türü	IBAN No
GARANTİ TOPTANCILAR ÇARŞISI ŞUBESİ (269)	TR	TR25 0006 2000 2690 0006 2013 00
	EURO	TR76 0006 2000 2690 0009 0021 30
	USD	TR04 0006 2000 2690 0009 0021 65
YAPI KREDİ EGE ŞUBESİ	TR	TR09 0006 7010 0000 0068 0744 39
	EURO	TR45 0006 7010 0000 0068 1202 54
	USD	TR91 0006 7010 0000 0068 1233 06
İŞ BANKASI GIDA ÇARŞISI ŞUBESİ (3456)	TR	TR61 0006 4000 0013 4560 0486 44
	EURO	TR37 0006 4000 0023 4560 0316 11
	USD	TR75 0006 4000 0023 4560 0316 06
HALKBANK TOPTANCILAR SİTESİ / İZMİR ŞUBESİ (437)	TR	TR94 0001 2009 4370 0010 2601 88
	EURO	TR80 0001 2009 4370 0058 0000 57
	USD	TR77 0001 2009 4370 0053 0003 43

## İLETİŞİM BİLGİLERİMİZ

İZMİR
FRİGODUMAN SOĞUTMA SAN. ve TİC. A.Ş. 2818 Sokak No: 24 Mersinli / İZMİR Tel: +90 232 469 05 00 (Pbx) Fax: +90 232 449 78 33 e-mail: frigoduman@frigoduman.com
İSTANBUL
FRİGODUMAN SOĞUTMA SAN. ve TİC. A.Ş. Irmak Caddesi No: 75 Dolapdere / İSTANBUL Tel: +90 212 237 97 77 (Pbx) Fax: +90 212 237 97 37 e-mail: istanbul@frigoduman.com

**DİKKAT: İnternet sitemizdeki fiyatlar sürekli güncellenmektedir. Sitemizdeki fiyatlar ile karşılaştırmadan işleme almayınız.**



Ürün Adı	Sayfa
FUSHENG Vidalı Kompresörler ( BSR - SRT - SST )	4
MITSUBISHI - SIAM DC Inverter Scroll Kompresörler	8
ALFA LAVAL Plakalı Isı Değişiriciler	12
DANFOSS H Serisi Scroll Kompresörler	14
DANFOSS SZ Serisi Scroll Kompresörler	15
DANFOSS H Serisi Scroll Kompresörler - R410A	16
DANFOSS SH ve DSH Serisi Scroll Kompresörler	17
DANFOSS MLZ Serisi Scroll Kompresörler	18
DANFOSS LLZ Serisi Scroll Kompresörler	20
DANFOSS NTZ Serisi Hermetik Pistonlu Kompresörler	21
DANFOSS MTZ Serisi Hermetik Pistonlu Kompresörler	22
DANFOSS Ticari Kompresörler	24
DANFOSS BOCK Kompresör	25
DANFOSS Elektronik Genleşme Valfleri	27
DANFOSS MCX Programlanabilir Kontrol Cihazları	30
DANFOSS Termostatlar	31
KELLER Transmitterler	31
DANFOSS Presostatlar, Mekanik Termostatlar	33
DANFOSS Değişirilebilir Orifisli Genleşme Valfleri T2 /TE2	34
DANFOSS Değişirilebilir Orifisli Genleşme Valfleri TE5 / 12 / 20 / 55	36
DANFOSS Sabit Orifisli Genleşme Valfleri	38
DANFOSS TUAE Serisi Çift Yönlü Genleşme Valfleri R-410A	40
DANFOSS Heat Exchanger ve Emiş filtreleri	41
DANFOSS Rakorlu ve Kaynaklı Taş Drierler, Kartuş Kovanları, Çift Yönlü Drierler	42
DANFOSS Solenoid Valfler ve Bobinler	44

Ürün Adı	Sayfa
DANFOSS Regülatörler	46
DANFOSS Gözetleme Camları	47
DANFOSS Küresel Vanalar, Su Regülatör Valfleri	48
DANFOSS Cekvalfler (Check Valfler)	49
DANFOSS - SAGINOMIYA 4 yollu Solenoid Valfler, Fan Hız Kontrol Modülleri	50
WENTO Aksiyel ve Plug Fanlar	51
CUOGHI Nem alma ve Adyabatik Nemlendiriciler	54
SEUNGİL Sıcak Buhar Nemlendiriciler	56
SYSLAB Parametrik Kontrol Cihazları	58
MATCHWELL Elektronik Basınç Presostatları - Fan Coil Motoru	61
HONGSEN Gözetleme Camları, Absorberler	62
HONGSEN Genleşme Valfleri, Küresel Vanalar	63
HONGSEN Rakorlu, Kaynaklı ve Çift Yönlü Drierler, Kartuş Kovanları	64
HONGSEN Cekvalfler, Solenoid Valfler ve Bobinleri	66
HONGSEN Servis El Aletleri	68
P&M Servis El Aletleri	70
Eckerle Drenaj Pompaları	72
WENTO R-134A DC 12-24 V ( LBP / MBP ) Kompresörler	73
FULL GAUGE Kontrol Cihazları	74
VALEO Araç Klima Kompresörleri WENTO Flow Switch	75
F-Gas Doldurulabilir Tüpte Soğutucu Gazlar	76
Bakır Fittings	77
GVN Likit Tankları, Emiş Akümülatörler, Yağ Ayırıcılar	78
DYNAFLEX Kauçuk Yalıtım Ürünleri	82
Mail Order Formu	88

## FUSHENG KAPASİTE LİSTESİ / BSR

Gaz Tipi		R404A		R134A		R407C	
Model	Evaporasyon	-10°C	0°C	-10°C	0°C	-10°C	0°C
	Kondenzasyon						
BSR 213	40°C	76,60	113,55	44,17	69,46	67,10	102,57
	50°C	62,82	94,50	36,69	59,81	55,27	88,28
BSR 216	40°C	97,60	144,67	56,28	88,49	85,70	131,00
	50°C	80,04	120,40	46,74	76,20	70,58	112,75
BSR 311	40°C	135,39	199,75	72,02	113,25	108,80	166,33
	50°C	102,46	154,13	59,82	97,52	89,61	143,16
BSR 314	40°C	155,93	231,14	89,89	141,34	136,60	208,82
	50°C	127,88	192,36	74,66	121,71	112,51	179,73
BSR 316	40°C	183,72	272,34	105,91	166,54	160,00	244,59
	50°C	150,67	226,65	87,97	143,41	131,78	210,52
BSR 321	40°C	196,87	291,83	114,75	180,43	171,49	262,16
	50°C	161,46	242,87	95,31	155,37	141,25	225,64
BSR 323	40°C	234,94	348,26	136,93	215,32	204,65	312,85
	50°C	192,67	289,83	113,73	185,41	168,56	269,27
BSR 324	40°C	261,65	387,86	151,90	238,85	227,02	347,04
	50°C	214,58	322,79	126,17	205,67	186,98	298,70
BSR 326	40°C	280,73	416,14	163,63	257,29	244,55	373,84
	50°C	230,23	346,33	135,91	221,56	201,42	321,77
BSR 413	40°C	338,29	501,47	199,25	313,30	298,12	455,73
	50°C	277,44	417,34	165,49	269,78	245,54	392,25
BSR 415	40°C	376,32	557,85	221,65	348,52	331,63	506,96
	50°C	308,62	464,26	184,09	300,11	273,14	436,34
BSR 421	40°C	435,63	645,76	254,99	400,95	381,80	583,65
	50°C	357,27	537,43	211,79	345,26	314,46	502,35
BSR 423	40°C	475,41	704,72	278,27	437,56	416,66	636,94
	50°C	389,88	586,50	231,12	376,78	343,17	548,22
BSR 424	40°C	533,89	791,42	314,17	494,01	470,49	719,23
	50°C	437,85	658,65	260,94	425,39	387,51	619,05
BSR 426	40°C	589,15	873,33	346,69	545,13	519,18	793,67
	50°C	483,17	726,82	287,95	469,41	427,61	683,12
BSR 427	40°C	650,35	964,05	383,48	599,17	573,11	876,11
	50°C	533,36	802,32	321,50	519,05	472,03	754,07
BSR 428	40°C	697,26	1033,59	411,14	642,40	614,46	939,32
	50°C	571,83	860,20	344,69	556,49	506,09	808,47



**FUSHENG (BSR) SERİSİ VİDALI KOMPRESÖRLER**

Model	Disp. (m <sup>3</sup> /h)	HP	Kw	Voltaj	Basma / Emme	Gaz	Çalışma Aralığı	Fiyat
<b>BSR 213</b>	140	45	38	(380 / 415) - 3 - 50 Hz	1 5/8" 2 5/8"	R22 - R134A - R407C - R404A	+15°C / -30°C	<b>6.515,28 \$</b>
<b>BSR 216</b>	172	60	46		1 5/8" 2 5/8"			<b>7.147,44 \$</b>
<b>BSR 311</b>	211	75	56		2 5/8" 3 1/8"			<b>7.770,36 \$</b>
<b>BSR 314</b>	268	90	70		2 5/8" 3 1/8"			<b>8.040,89 \$</b>
<b>BSR 316</b>	316	100	79		2 5/8" 3 1/8"			<b>8.335,21 \$</b>
<b>BSR 321</b>	335	120	87		3 1/8" 4"			<b>9.215,74 \$</b>
<b>BSR 323</b>	395	140	103		3 1/8" 4"			<b>9.505,05 \$</b>
<b>BSR 324</b>	438	150	113		3 1/8" 4"			<b>10.267,34 \$</b>
<b>BSR 326</b>	472	160	122		3 1/8" 4"			<b>10.520,99 \$</b>
<b>BSR 413</b>	555	200	145		3 1/8" 4"			<b>11.213,59 \$</b>
<b>BSR 415</b>	619	220	161		3 1/8" 4"			<b>13.255,60 \$</b>
<b>BSR 421</b>	689	240	183		4" 5"			<b>14.755,40 \$</b>
<b>BSR 423</b>	760	270	201		4" 5"			<b>15.208,29 \$</b>
<b>BSR 424</b>	841	300	221		4" 5"			<b>15.684,88 \$</b>
<b>BSR 426</b>	942	330	247		4" 5"			<b>17.251,71 \$</b>
<b>BSR 427</b>	1269	345	267		4" 5"			<b>19.511,08 \$</b>
<b>BSR 428</b>	1337	380	283	4" 5"	<b>20.785,09 \$</b>			

Emiş ve Dönüş vanası, karter ısıtıcısı, emiş flitresi, entegre check valf, flanşlı yağ ayırıcı, yağ seviye siviçi, yağ gözetleme camı, yağ filitresi, 4 kademeli kapasite kontrol (100-75-50-25%) veya Kademesiz kontrol (100..25%), Motor PTC sensörü, Basma sıcaklık sensörü PTC, Yağ boşaltma vanası, Ekonomizer bağlantı portu, Likit enjeksiyon adaptörleri, INT69 Motor kontrollü elektrik motoru, IP54 sınıfı terminal, Kompresör takozları.

\* BSR 5xx serisi standart ve opsiyonel parçaları için bilgi alınız.



**FUSHENG KAPASİTE LİSTESİ / SRT**

Gaz Tipi		R404A			R22		
Model	Evaporasyon	-60°C	-50°C	-40°C	-60°C	-50°C	-40°C
	Kondenzasyon						
<b>SRT 218</b>	40°C	11,24	18,71	29,21	9,81	16,55	26,13
	50°C	10,73	17,95	28,03	9,42	16,06	25,40
<b>SRT 314</b>	40°C	20,61	34,29	53,54	17,97	30,32	47,88
	50°C	20,13	33,59	52,46	17,24	29,41	46,52
<b>SRT 321</b>	40°C	30,04	49,97	78,01	26,18	44,19	69,78
	50°C	28,56	47,85	74,77	25,11	42,85	67,81
<b>SRT 324</b>	40°C	40,80	67,87	105,96	35,58	60,03	94,80
	50°C	38,79	64,99	101,59	34,09	58,19	92,09
<b>SRT 413</b>	40°C	50,28	83,66	130,62	43,85	73,99	116,84
	50°C	47,80	80,10	125,20	42,04	71,74	113,51
<b>SRT 415</b>	40°C	59,77	99,44	155,26	52,13	87,95	138,88
	50°C	56,83	95,20	148,81	49,97	85,26	134,93
<b>SRT 424</b>	40°C	80,50	134,00	209,40	70,90	119,60	188,90
	50°C	76,60	128,30	200,60	68,00	115,80	183,40

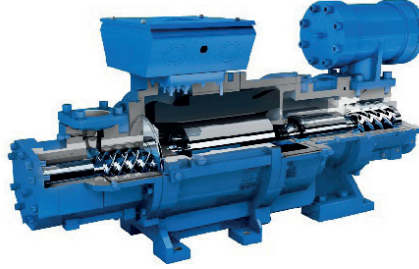

**FUSHENG KAPASİTE LİSTESİ / SST**



Gaz Tipi		R404A			R22		
Model	Evaporasyon	-60°C	-50°C	-40°C	-60°C	-50°C	-40°C
	Kondenzasyon						
<b>SST 100</b>	40°C	9,6	16,0	24,9	8,4	14,3	22,5
	50°C	9,1	15,3	23,9	8,1	13,8	21,9
<b>SST 140</b>	40°C	13,4	22,4	34,9	11,8	19,9	31,5
	50°C	12,8	21,4	33,5	11,4	19,3	30,6
<b>SST 170</b>	40°C	16,3	27,1	42,4	14,4	24,2	38,3
	50°C	15,6	26,0	40,7	13,8	23,5	37,2

## FUSHENG (SRT) SERİSİ ÇİFT KADEME VİDALI KOMPRESÖRLER

Model	Disp. (m <sup>3</sup> /h)	Nominal Güç (HP)	Voltaj	Basma / Emme		Gaz	Çalışma Aralığı	Fiyat
SRT 218	120	45	(380 / 415) -3-50Hz	1 5/8"	2 5/8"	R22 - R404A	-30°C / -65°C	11.635,34 \$
SRT 314	222	60		1 5/8"	2 5/8"			16.722,00 \$
SRT 321	320	95		2 5/8"	4"			21.221,56 \$
SRT 324	430	125		2 5/8"	4"			23.145,33 \$
SRT 413	530	150		3 1/8"	4"			27.086,00 \$
SRT 415	630	175		3 1/8"	4"			30.030,00 \$
SRT 424	730	200		3 1/8"	4"			48.592,00 \$

Basma flanşı ve conta takımı, emiş flanşı ve conta takımı, emiş filtresi, 5 adet kapasite kontrol solenoidi veya kademesiz kontrol (100..25%), motor sargısı PTC termistörü, basma sıcaklık sensörü PTC, ekonomizer enjeksiyon portu, likit enjeksiyon adaptörleri, asbetsiz conta takımı, entegre check valf, emiş ve dönüş vanası, kompresör takozları, INT69 FSY motor koruma kontrolü.

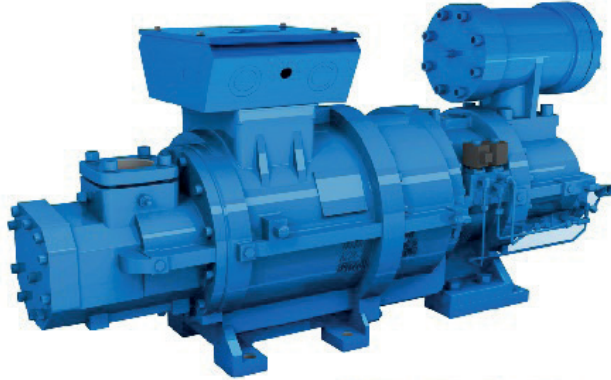

## FUSHENG (SST) ÇİFT KADEME SCROLL VİDALI KOMPRESÖRLER

Model	Disp. (m <sup>3</sup> /h)	Voltaj	Basma / Emme		Gaz	Çalışma Aralığı	Fiyat
SST 100	100	(380 / 415) -3-50Hz	1 5/8"	2 5/8"	R22-R404A-R507	-33°C / +55°C	10.158,80 \$
SST 140	140						12.992,80 \$
SST 170	170						15.172,80 \$





### MITSUBISHI R410A DC INVERTER SCROLL 400 Volt (TANDEM UYUMLU)

Model	Kapasite (min-max)		Cop. (60 rps)	Fiyat
	Kw	Btu		
<b>ANB 33</b> FBRMT1 (20-120 rps)	3,29 Kw - 21,5 Kw	11.230 - 73.360	3,27	<b>1.035,00 \$</b>
<b>ANB 42</b> FBRMT1 (20-120 rps)	4,15 Kw - 27,3 Kw	14.160 - 93.150	3,34	<b>1.130,00 \$</b>
<b>ANB 52</b> FKEMT1 (20-120 rps)	5,45 Kw - 33,1 Kw	18.600 - 112.940	3,28	<b>1.225,00 \$</b>
<b>ANB 66</b> FKEMT1 (20-120 rps)	5,93 Kw - 34,5 Kw	23.540 - 136.800	3,31	<b>1.320,00 \$</b>

### MITSUBISHI R410A DC INVERTER SCROLL 400 Volt (TANDEM UYUMLU ve YAĞ SEVİYE SENSÖRLÜ)

Model	Kapasite (min-max)		Cop. (60 rps)	Fiyat
	Kw	Btu		
<b>ANB 78</b> FGAMT (15-120 rps)	5,75 Kw - 49,3 Kw	19.606 - 168.235	3,32	<b>1.370,00 \$</b>
<b>ANB 87</b> FGAMT (15-120 rps)	6,52 Kw - 55,4 Kw	22.226 - 189.059	3,29	<b>1.398,00 \$</b>

### ELEKTRONİK YAĞ SEVİYE DEDEKTÖRÜ

Model	Marka	Fiyat
<b>OS-1</b> (Yağ seviye Ana Modül)	INTRONICS	<b>87,05 \$</b>
<b>03UEAF</b> (Modbus Ayar ekranı)	INTRONICS	<b>78,02 \$</b>

### DC INVERTER KONTROL

Model	Marka	Bağlantı	Fiyat
<b>IBC-A35-4-01A</b> (ANB33-42-52-66-78 için)	Mitsubishi	380V-50-60Hz	<b>939,67 \$</b>
<b>F015i-4TXB</b> (ANB33-42)	Frecon		<b>1.265,00 \$</b>
<b>F020i-4TXB</b> (ANB52-66-78)			<b>1.298,00 \$</b>
<b>F025i-4TXB</b> (ANB87)			<b>1.536,25 \$</b>

\* DC Inverter Kontrol, Kompresör fiyatına dahil değildir.

\* Kompresörler tandem bağlantıya uygundur.



### MITSUBISHI R404A DC INVERTER SCROLL 400 Volt

Model	Kapasite (min-max)		Cop. (60 rps)	Fiyat
	Kw	Btu		
AGB 33FBAMTS (15-120 rps)	0,60 Kw - 3,20 Kw	2.047 - 10.918	2,05	<b>1.066,00 \$</b>
AGB 42FCAMTS (15-120 rps)	1,75 Kw - 11,29 Kw	5.971 - 38.521	2,15	<b>1.159,00 \$</b>
AGB 66FAAMTS (15-120 rps)	1,86 Kw - 16,54 Kw	6.323 - 56.409	2,07	<b>1.348,00 \$</b>
AGB 78FAAMTS (15-120 rps)	2,37 Kw - 19,47 Kw	8.090 - 66.424	2,09	<b>1.393,00 \$</b>
AGB 87FG1MTS (15-120 rps)	3,78 Kw - 23,89 Kw	12,900 - 81.515	2,21	<b>1.420,00 \$</b>

### YAĞ AYIRICI

Model	Uygunluk		Fiyat
	Inverter	Sabit Hızlı	
MUTO-A2053N	AGB33	AGB33-AGB42-AGB66	<b>119,90 \$</b>
MUTO-A4053N	AGB33-AGB42-AGB66-AGB78	AGB66-AGB78-AGB87	<b>131,54 \$</b>

### DC INVERTER KONTROL

Model	Marka	Uyumluluk	Bağlantı	Fiyat
SDP-042PF 230	MITSUBISHI	SNB 130-172/TNB 220-306	<b>1 x 230V</b>	<b>459,00 \$</b>
SDP-105AC 400		ADB33/AGB33-42	<b>3 x 380V</b>	<b>776,70 \$</b>
SDP-140AC 400		ANB33-52/ADB66/AGB66	<b>50-60HZ</b>	<b>799,70 \$</b>
SDP-220AC 400		ANB78-87/ADB78/AGB78-87	RS485 - MODBUS	<b>856,70 \$</b>

### MITSUBISHI R410A DC INVERTER TWIN ROTARY (220V)

Model	Kapasite (min-max)		Cop. (60 rps)	Fiyat
	Kw	Btu		
SNB 092FQAMT (15-130rps)	844 W - 6.408 W	2.866 - 21.866	3,06	<b>342,50 \$</b>
SNB 110FGYMT (15-130rps)	850 W - 7.367 W	2.900 - 25.135	3,18	<b>352,00 \$</b>
SNB 130FQYMT (10-130rps)	868 W - 9.670 W	2.960 - 33.025	3,18	<b>361,00 \$</b>
SNB 172FKEMT (15-130rps)	1.330 W - 10.835 W	4.540 - 37.000	3,1	<b>366,00 \$</b>
TNB 220FLHMT (15-120rps)	1.602 W - 14.392 W	5.470 - 49.100	3,24	<b>474,00 \$</b>
TNB 306FPGMT (15-120rps)	2.245 W - 20.676 W	7.660 - 70.550	3,28	<b>641,00 \$</b>

### DC INVERTER KONTROL

Model	Marka	Bağlantı	Fiyat
IBC-A35-AT35T4-X2 (AGB78/AGB87)	MITSUBISHI	<b>1 x 230V</b> <b>50-60HZ</b> RS485 - MODBUS	<b>939,70 \$</b>
F003İ-2PHB 18A (SNB130)	FRECON		<b>773,00 \$</b>
F003İ-2PHB 13A-R02 (SNB170)			<b>773,00 \$</b>
F007İ-2PHB 07C (TNB220)			<b>831,00 \$</b>
F008İ-2PHB 09B (TNB306)			<b>896,00 \$</b>

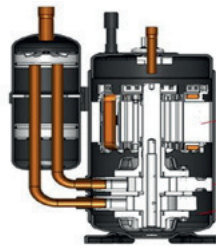

Yüksek verimli motor

Yeni sabitleme iç yapısı ile daha az titreşim.

PVE yağ

## MITSUBISHI ROTARY KOMPRESÖR R410A

Model	Kw 50 Hz.	BTU 50 Hz.	Voltaj	Emme Basma		Özellik	Fiyat
PN 27VAAMT	6.800	23.202	220 V 50 Hz 1 Faz	5/8"	3/8"	ÇALIŞMA SICAKLIĞI +23°C / -27°C	329,00 \$
PN 33VABMT	8.490	28.968		3/4"	3/8"		331,00 \$
NN 40VAAMT	10.200	34.802		5/8"	3/8"		435,00 \$
NN 21YDAMT	5.200	18.000	380 V 50 Hz	3/8"	449,50 \$		
NN 27YDAMT	6.980	24.000			455,25 \$		
NN 31YCAMT	8.060	27.501			459,75 \$		
NN 33YCAMT	8.600	29.344			465,00 \$		
NN 37YCAMT	9.600	32.000			471,50 \$		
NN 40YCAMT	10.400	35.484	3/4"	3/8"	476,20 \$		
NN 44YCAMT	11.400	38.897			483,34 \$		

## MITSUBISHI ROTARY KOMPRESÖR R410A

Model	Kondansatör	BTU	Voltaj	Emme Basma		Fiyat
RN 110VHSMT	370/25	9.087	220 V 50 Hz	3/8"	3/8"	218,50 \$
RN 145VHSMT	370/30	12.181		1/2"		252,75 \$
RN 220VHSMT	370/45	18.700		1/2"		299,25 \$

## MITSUBISHI ROTARY KOMPRESÖR R22

Model	Kondansatör	BTU	Voltaj	Emme Basma		Fiyat
RH 154VHST	370/25	9.087	220 V 50 Hz	3/8"	5/16"	211,00 \$
RH 207VRFT	400/40	12.290				221,00 \$
RH 313VADT	370/45	19.244				259,25 \$
PH 39VTET	400/60	24.000				309,00 \$



**MITSUBISHI SCROLL KOMPRESÖR R410A**

Model	Nominal Güç	BTU 50 Hz.	Voltaj	Emme Basma		Özellik	Fiyat
<b>AN 30YBFMT</b>	3 HP	26.100	380V	3/4"	1/2"	<b>ÇALIŞMA SICAKLIĞI +12°C / -20°C</b> 	<b>570,00 \$</b>
<b>AN 33YBFMT</b>	3,3 HP	28.770					<b>581,00 \$</b>
<b>AN 36YBFMT</b>	3,8 HP	32.420					<b>595,00 \$</b>
<b>AN 42YBFMT</b>	4 HP	36.850					<b>612,00 \$</b>
<b>AN 47YBFMT</b>	4,5 HP	41.390		7/8"	<b>623,00 \$</b>		
<b>AN 52YBFMT</b>	5 HP	46.400			<b>647,00 \$</b>		
<b>BN 57YFAMT</b>	5,5 HP	52.200			<b>824,00 \$</b>		
<b>BN 65YFAMT</b>	6 HP	60.000			<b>868,00 \$</b>		

**MITSUBISHI SCROLL KOMPRESÖR R410A TANDEM UYUMLU**

Model	Nominal Güç	BTU 50 Hz.	Voltaj	Emme Basma		Özellik	Fiyat
<b>AN 33YBUMT</b>	3,3 HP	28.770	380V	3/4"	1/2"	<b>ÇALIŞMA SICAKLIĞI +12°C / -20°C</b>	<b>642,00 \$</b>
<b>AN 42YBUMT</b>	4 HP	36.850					<b>673,00 \$</b>
<b>AN 52YBUMT</b>	5 HP	46.400		7/8"	<b>710,00 \$</b>		
<b>AN 66YQDMT</b>	6,2 HP	60.000			<b>725,00 \$</b>		



## ALFA LAVAL PLAKALI ISI DEĞİŞTİRİCİLER

Model	Plaka Sayısı	Fiyat
AC-30EQ-10H	10	218,48 €
AC-30EQ-14H	14	242,60 €
AC-30EQ-20H	20	276,79 €
AC-30EQ-24H	24	298,89 €
AC-30EQ-30H	30	334,40 €
AC-30EQ-36H	36	369,26 €
AC-30EQ-40H	40	394,05 €
AC-30EQ-44H	44	417,51 €
AC-30EQ-54H	54	473,81 €
AC-30EQ-60H	60	510,01 €
AC-220EQ-16AM-F	16	1.014,25 €
AC-220EQ-18AM-F	18	1.018,50 €
AC-220EQ-20AM	20	1.086,40 €
AC-220EQ-28AM-F	28	1.246,75 €
AC-220EQ-36AM	36	1.444,60 €
AC-220EQ-42AM	42	1.597,00 €
AC-220EQ-50AM	50	1.791,00 €
AC-220EQ-76AM	76	5.011,94 €
AC-220EQ-94AM	94	5.915,42 €
AC-220EQ-110AM	110	6.722,06 €

AC-30EQ = 35 bar

AC-220EQ = 32 bar





## ALFA LAVAL YÜKSEK BASINÇ PLAKALI ISI DEĞİŞTİRİCİLER

Model	Plaka Sayısı	Fiyat
ACH-30EQ-10H	10	237,24 €
ACH-30EQ-14H	14	265,40 €
ACH-30EQ-20H	20	308,95 €
ACH-30EQ-24H	24	337,10 €
ACH-30EQ-30H	30	380,67 €
ACH-30EQ-36H	36	423,53 €
ACH-30EQ-40H	40	437,61 €
ACH-30EQ-44H	44	480,51 €
ACH-30EQ-54H	54	552,22 €
ACH-30EQ-60H	60	566,97 €
ACH-30EQ-80H	80	696,31 €
ACH-220EQ-24AM-F	24	1.235,20 €
ACH-220EQ-36AM	36	1.543,10 €
ACH-220EQ-50AM	50	1.921,20 €
ACH-220EQ-68AM	68	2.405,50 €
ACH-220EQ-86AM	86	2.915,00 €

ACH-30EQ = 50 bar  
ACH-220EQ = 45 bar



## DANFOSS H SERİSİ SCROLL KOMPRESÖRLER

### R404A / R507 - R407C - R134A

Model	Kod No	Btu 50 Hz.	Disp. CC	Nominal Güç	Voltaj	Emme Basma		Çalışma Rejimi	Yağ Miktarı (Lt)	Fiyat
HRP 034 T5LP6	120U2019	28.333	46,21	2,8 Hp	220 V	3/4"	1/2"			
HRP 034 T4LP6	121L2024	28.333	46,21	2,8 Hp	380 V / 400V 50Hz 460V 60Hz	3/4"	1/2"	1,06	<b>678,81 €</b>	
HRP 040 T4LP6	121L1016	33.333	54,4	3,3 Hp		3/4"	1/2"	1,06	<b>697,32 €</b>	
HRP 048 T4LP6	120U1656	38.400	64,4	4 Hp		7/8"	1/2"	1,57	<b>790,29 €</b>	
HRP 060 T4LP6	121L1726	48.000	80,95	5 Hp		7/8"	1/2"	1,57	<b>813,54 €</b>	
HLP 072 T4LC6	121L1756	57.600	98,65	6 Hp		7/8"	1/2"	1,57	<b>866,52 €</b>	
HLP 081 T4LC6	121L1781	64.800	110,94	6,5 Hp		7/8"	3/4"	1,57	<b>911,16 €</b>	
HCP 094 T4LC6	121L0601	75.200	126,02	8 Hp		11/8"	7/8"	2,66	<b>1.283,05 €</b>	
HCP 109 T4LC6	121L0376	87.200	148,79	9 Hp		11/8"	7/8"	2,66	<b>1.329,55 €</b>	
HCP 120 T4LC6	121L0401	96.000	162,4	10 Hp		11/8"	7/8"	2,66	<b>1.376,04 €</b>	

## DANFOSS H SERİSİ TANDEM KOMPRESÖRLER

Model	Kod No	Btu 50 Hz.	Disp. CC	Nominal Güç	Voltaj	Emme Basma		Çalışma Rejimi	Yağ Miktarı (Lt)	Fiyat
HRP 048 T4LC8	120U1661	38.400	64,4	4 Hp	380 V / 400V 50Hz 460V 60Hz	7/8"	1/2"			
HRP 060 T4LC8	120U1731	48.000	80,95	5 Hp		7/8"	1/2"	1,57	<b>839,49 €</b>	
HLP 072 T4LC8	120U2072	57.600	98,65	6 Hp		7/8"	1/2"	1,57	<b>953,18 €</b>	
HLP 081 T4LC8	121L1786	64.800	110,94	6,5 Hp		7/8"	3/4"	1,57	<b>1.002,27 €</b>	
HCP 094 T4LC8	121L0611	75.200	126,02	8 Hp		11/8"	7/8"	2,66	<b>1.481,28 €</b>	
HCP 109 T4LC8	121L0386	87.200	148,79	9 Hp		11/8"	7/8"	2,66	<b>1.535,44 €</b>	
HCP 120 T4LC8	121L0411	96.000	162,4	10 Hp		11/8"	7/8"	2,66	<b>1.581,47 €</b>	

\* Kompresörler kaynak bağlantılıdır. Karter ısıtıcısı 30,28 Euro'dur. \*Subcooling: 0°K, Superheat: 10°K, Gaz: R407C

Model Kod No	Voltaj	Evaporasyon		-25°C	-20°C	-15°C	-10°C	-5°C	-0°C	+5°C	+10°C
		Kondenzasyon									
HRP 034 T5LP6	380V / 400 V 50 Hz 460 V 60 Hz	40°C	2.002	2.695	3.496	4.430	5.523	6.802	8.292	10.020	
		50°C	-	-	2.987	3.818	4.795	5.944	7.290	8.859	
HRP 034 T4LP6	380V / 400 V 50 Hz 460 V 60 Hz	40°C	2.129	2.759	3.518	4.424	5.496	6.749	8.203	9.874	
		50°C	-	-	2.976	3.779	4.727	5.838	7.130	8.620	
HRP 040 T4LP6	380V / 400 V 50 Hz 460 V 60 Hz	40°C	2.445	3.169	4.041	5.082	6.313	7.753	9.423	11.340	
		50°C	-	-	3.416	4.338	5.426	6.702	8.185	9.896	
HRP 048 T4LP6	380V / 400 V 50 Hz 460 V 60 Hz	40°C	2.971	3.846	4.902	6.165	7.658	9.406	11.430	13.760	
		50°C	-	-	4.160	5.279	6.603	8.155	9.961	12.040	
HRP 060 T4LP6	380V / 400 V 50 Hz 460 V 60 Hz	40°C	3.726	4.801	6.110	7.681	9.544	11.730	14.260	17.180	
		50°C	-	-	5.232	6.612	8.530	10.180	12.430	15.030	
HLP 072 T4LC6	380V / 400 V 50 Hz 460 V 60 Hz	40°C	4.746	6.111	7.753	9.719	12.060	14.810	18.030	21.770	
		50°C	-	-	6.529	8.184	10.100	12.420	15.170	18.390	
HLP 081 T4LC6	380V / 400 V 50 Hz 460 V 60 Hz	40°C	5.051	6.454	8.190	10.290	12.790	15.710	19.100	22.970	
		50°C	-	-	7.237	9.130	11.400	14.080	17.210	20.810	
HCP 094 T4LC6	380V / 400 V 50 Hz 460 V 60 Hz	40°C	5.720	7.374	9.387	11.800	14.660	18.010	21.890	26.340	
		50°C	-	-	8.068	10.220	12.780	15.780	19.280	23.300	
HCP 109 T4LC6	380V / 400 V 50 Hz 460 V 60 Hz	40°C	7.254	8.949	11.290	14.240	17.750	21.780	26.280	31.210	
		50°C	-	-	9.893	12.300	15.360	19.030	23.270	28.030	
HCP 120 T4LC6	380V / 400 V 50 Hz 460 V 60 Hz	40°C	8.045	9.902	12.450	15.640	19.460	23.860	28.820	34.300	
		50°C	-	-	10.870	13.410	16.670	20.620	25.250	30.500	

## DANFOSS SZ SERİSİ SCROLL KOMPRESÖRLER R407C - R134A

Model	Btu 50 Hz.	Disp. CC	Nominal Güç	Volтаж	Emme Basma		Çalışma Rejimi	Yağ Miktarı (Lt)	Fiyat
<b>SZ 090-4VI</b>	72.000	120,5	7,5 Hp	380 V / 400V 50Hz 460V 60Hz	1 1/8"	3/4"	+15°C / -20 °C (MBP)	3,3	<b>1.297,79 €</b>
<b>SZ 100-4VI</b>	80.000	127,2	8,0 Hp		1 1/8"	3/4"		3,3	<b>1.349,01 €</b>
<b>SZ 110-4VI</b>	88.000	144,2	9,0 Hp		1 3/8"	7/8"		3,3	<b>1.433,27 €</b>
<b>SZ 120-4VI</b>	96.000	166,6	10 Hp		1 3/8"	7/8"		3,3	<b>1.486,96 €</b>
<b>SZ 125-4RI</b>	104.150	166,6	10 Hp		1 3/8"	7/8"		3,8	<b>1.606,76 €</b>
<b>SZ 148-4VAI</b>	119.800	199,0	12 Hp		1 3/8"	7/8"		3,6	<b>1.710,01 €</b>
<b>SZ 160-4RAI</b>	129.700	216,6	13 Hp		1 5/8"	1 1/8"		4	<b>2.086,36 €</b>
<b>SZ 161-4VAI</b>	129.700	216,6	13 Hp		1 3/8"	7/8"		3,6	<b>1.774,44 €</b>
<b>SZ 175-4RI</b>	140.000	233,0	14 Hp		1 5/8"	1 1/8"		6,2	<b>2.228,62 €</b>
<b>SZ 185-4CAI</b>	148.000	249,9	15 Hp		1 5/8"	1 1/8"		6,2	<b>1.961,14 €</b>
<b>SZ 185-4RI</b>	148.000	249,9	15 Hp		1 5/8"	1 1/8"		6,2	<b>1.961,14 €</b>
<b>SY 240-A4PBI</b>	201.700	347,8	20 Hp		1 5/8"	1 1/8"		8	<b>3.014,41 €</b>
<b>SY 300-A4PBI</b>	248.100	437,5	25 Hp		1 5/8"	1 1/8"		8	<b>3.399,36 €</b>
<b>SY 380-A4CBI</b>	305.800	531,2	30 Hp		2 1/8"	1 3/8"		8,5	<b>3.876,01 €</b>

\* Kompresörler kaynak bağlantılıdır. Karter ısıtıcısı 30,28 Euro'dur.

\* R407C \* Watt

Model Kod No	Volтаж	Evaporasyon		--20°C	-15°C	-10°C	-5°C	-0°C	+5°C	+10°C	+15°C
		Kondenzasyon									
<b>SZ 090-4VI</b>	380V / 400 V 50 Hz 460 V 60 Hz	40°C	6.562	8.540	10.910	13.710	17.010	20.840	25.520	30.290	
		50°C	-	-	9.359	11.870	14.810	18.250	22.220	26.780	
<b>SZ 100-4VI</b>		40°C	6.976	9.075	11.580	14.550	18.030	22.060	26.710	32.010	
		50°C	-	-	9.934	12.590	15.700	19.320	23.500	28.300	
<b>SZ 110-4VI</b>		40°C	8.019	10.430	13.290	16.660	20.610	25.170	30.400	36.370	
		50°C	-	-	11.390	14.410	17.950	22.040	26.760	32.150	
<b>SZ 120-4VI</b>		40°C	9.391	12.250	15.590	19.490	24.020	29.260	35.280	42.160	
		50°C	-	-	13.320	16.830	20.900	25.610	31.030	37.230	
<b>SZ 125-4VI</b>		40°C	9.237	19.090	15.460	19.410	23.990	29.270	35.310	42.160	
		50°C	-	-	13.170	16.730	20.870	25.640	31.100	37.320	
<b>SZ 148-4VAI</b>		40°C	11.630	15.020	19.010	23.700	29.180	35.540	42.890	51.300	
		50°C	-	-	16.510	20.710	25.620	31.330	37.930	45.530	
<b>SZ 160-4RAI</b>		40°C	12.780	16.500	20.910	26.080	32.140	39.140	47.290	56.580	
		50°C	-	-	18.130	22.760	28.190	34.500	41.820	50.240	
<b>SZ 161-4VAI</b>	40°C	12.580	16.240	20.550	25.620	31.550	38.440	44.640	55.530		
	50°C	-	-	17.850	22.400	27.710	33.890	41.060	49.300		
<b>SZ 175-4CAI</b>	40°C	13.310	17.230	21.870	27.320	33.660	40.970	49.340	58.850		
	50°C	-	-	18.830	23.710	29.400	35.970	43.510	52.00		
<b>SZ 185-4CAI</b>	40°C	14.310	18.520	23.500	29.360	36.170	44.020	53.020	63.240		
	50°C	-	-	20.230	25.480	31.590	38.650	46.750	55.980		
<b>SY 240-A4PBI</b>	40°C	19.310	25.060	31.840	39.810	49.140	59.980	72.490	86.850		
	50°C	-	21.500	27.580	34.700	43.040	52.750	63.990	76.930		
<b>SY 300-A4PBI</b>	40°C	25.040	31.800	39.770	49.140	60.080	72.790	87.460	104.300		
	50°C	-	27.800	34.990	43.450	53.350	64.890	78.250	93.610		
<b>SY 380-A4CBI</b>	40°C	31.210	39.600	49.510	61.140	74.720	90.440	108.500	129.200		
	50°C	-	34.340	43.250	53.690	66.880	80.030	96.360	115.100		

## DANFOSS H SERİSİ R410A SCROLL KOMPRESÖRLER

Model	Kod No	Btu 50 Hz.	Disp. CC	Nominal Güç	Voltaj	Emme Basma		Çalışma Rejimi	Yağ Miktarı (Lt)	Fiyat
HRH 036 U5LP6	121L1176	30.000	34,74	3 Hp	220V	3/4"	1/2"			
HRH 036 U4LP6	121L1201	30.000	34,74	3 Hp	380 V / 400V 50Hz 460V 60Hz	3/4"	1/2"	1,06	<b>503,21 €</b>	
HRH 040 U4LP6	121L1211	33.300	39,64	3,3 Hp		7/8"	1/2"	1,33	<b>571,33 €</b>	
HRH 044 U4LP6	121L1361	36.600	42,61	3,7 Hp		7/8"	1/2"	1,57	<b>604,30 €</b>	
HRH 054U4LP6	121L1376	45.000	52,11	4,5 Hp		7/8"	1/2"	1,57	<b>626,28 €</b>	
HLH 061 U4LP6	121L2052	50.800	57,78	5,1 Hp		7/8"	1/2"	1,57	<b>619,68 €</b>	
HLJ 072 U4LP6	121L1396	60.000	67,97	6 Hp		7/8"	1/2"	1,57	<b>654,84 €</b>	
HLJ 083 U4LP6	121L1401	70.000	78,08	7 Hp		7/8"	1/2"	1,57	<b>698,78 €</b>	

\* Kompresörler kaynak bağlantılıdır. Karter ısıtıcısı 30,28 Euro'dur.

\* R410A \* Watt

Model Kod No	Voltaj	Evaporasyon		-25°C	-20°C	-15°C	-10°C	-5°C	-0°C	+5°C	+10°C
		Kondenzasyon									
HRH 036	380V / 400 V 50 Hz 460 V 60 Hz	40°C		-	2.794	3.687	4.744	5.981	7.412	9.051	10.910
		50°C		-	-	-	3.945	5.053	6.329	7.789	9.446
HRH 040		40°C		-	3.221	4.249	5.468	6.893	8.542	10.430	12.580
		50°C		-	-	-	4.557	5.836	7.310	8.996	10.910
HRH 044		40°C		-	3.987	5.147	6.382	7.752	9.317	11.140	13.280
		50°C		-	-	-	5.206	6.565	8.014	9.613	11.420
HRH 054		40°C		-	4.915	6.344	7.867	9.555	11.480	13.730	16.360
		50°C		-	-	-	6.419	8.094	9.881	11.850	14.080
HLH 061		40°C		3.880	5.429	7.003	8.663	10.550	12.680	15.160	18.060
		50°C		-	-	5.323	7.133	8.991	10.980	13.170	15.640
HLJ 072	40°C		4.658	6.516	8.405	10.420	12.660	15.220	18.190	21.680	
	50°C		-	-	6.393	8.566	10.800	13.180	15.810	18.790	
HLJ 073	40°C		5.367	7.525	9.713	12.040	14.630	17.580	21.020	25.050	
	50°C		-	-	7.329	9.832	12.400	15.130	18.150	21.570	

**Uygulama:** \_\_\_\_\_

**H:** yüksek sıcaklık / iklimlendirme

**Ürün Grubu:** \_\_\_\_\_

**C:** hafif ticari scroll  
**R:** konut scroll (yeni platform)  
**L:** hafif ticari scroll (yeni platform)

**Soğutkan ve Yağlayıcı:** \_\_\_\_\_

**M:** R22, alkilbenzen yağlayıcı  
**P:** R407C, PVE yağlayıcı  
**H:** R410A, PVE yağlayıcı  
**J:** R410A, PVE yağlayıcı

**Model Varyasyonu:** \_\_\_\_\_

**T:** 7,2/54,4°C için optimize tasarım  
**U:** 7,2/37,8°C için optimize tasarım

**Nominal Kapasite:** \_\_\_\_\_

60 Hz arı koşullarda BIN BTU/SA.

**Tür** | **Ebat** | **Motor** | **Özellikler**

**HRH** | **036** | **U1L** | **P6**

**Diğer Özellikler**

	Yağ gözetleme camı	Yağ dengeleme	Yağ Tahliye	LP servis portu	Gaz dengeleme portu
<b>6</b>	Yok	Yok	Yok	Yok	Yok
<b>7</b>	Dişli	Yok	Yok	Yok	Yok
<b>8</b>	Yok	Sert Lehimli	Yok	Yok	Sert Lehimli

**Boru ve Elektrik Bağlantıları:**  
**P:** sert lehimli bağlantılar, tırnaklı terminaller  
**C:** sert lehimli bağlantılar, dişli terminaller

**Motor Koruması:**  
**L:** iç motor koruması

**Motor Voltaj Kodu:**  
**1:** 208-230V/1~/60 Hz  
**2:** 200-220V/3~/50 Hz & 208-230V/3~/60 Hz  
**4:** 380-400V/3~/50 Hz & 460V/3~/60 Hz  
**5:** 220-240V/1~/50 Hz  
**7:** 500V/3~/50 Hz & 575V/3~/60 Hz  
**9:** 380V/3~/60 Hz

## DANFOSS DSH SERİSİ R410A SCROLL KOMPRESÖRLER

Model	Kod No	Btu 50 Hz.	Disp. CC	Nominal Güç	Voltaj	Emme Basma		Çalışma Rejimi	Yağ Miktarı (Lt)	Fiyat
<b>DSH 090 A4ALD</b>	120H1511	76.730	88,4	8,0 Hp	380 V / 400V 50Hz 460V 60Hz	11/8"	7/8"	+25°C / -30 °C (MBP)	3	<b>1.384,94 €</b>
<b>DSH 105 A4ALD</b>	120H1521	90.300	103,5	9,0 Hp		13/8"	7/8"		3,3	<b>1.553,73 €</b>
<b>DSH 120 A4ALD</b>	120H1531	102.500	116,9	10 Hp		13/8"	7/8"		3,3	<b>1.638,12 €</b>
<b>DSH 140 A4ALD</b>	120H1541	116.400	133,0	12 Hp		13/8"	7/8"		3,3	<b>1.850,61 €</b>
<b>DSH 161 A4ALD</b>	120H1551	133.500	151,7	13 Hp		13/8"	7/8"		3,3	<b>1.985,49 €</b>
<b>DSH 184 A4ALD</b>	120H1561	149.100	170,3	15 Hp		13/8"	7/8"		3,6	<b>2.063,10 €</b>
<b>DSH 240 A4APC</b>	120H1374	201.500	227,6	20 Hp		15/8"	11/8"		6,1	<b>3.024,33 €</b>
<b>DSH 295 A4APC</b>	120H1370	246.500	276,5	25 Hp		15/8"	11/8"		6,1	<b>3.296,10 €</b>
<b>DSH 381 A4APD</b>	120H1366	311.900	345,0	30 Hp		15/8"	11/8"		6,1	<b>3.925,58 €</b>
<b>DSH 485 B4APC</b>	120H1362	401.000	442,6	40 Hp		15/8"	1 3/8"		6,1	<b>5.149,84 €</b>
<b>DSH 600 A4APC</b>	120H1378	493.200	553,0	50 Hp		21/8"	1 3/8"		6,1	<b>5.939,05 €</b>

\*Gaz: 410A, 7,2 °C / 54,4°C Superheat: 11,1°K, Subcooling: 8,3°K

## DANFOSS SH SERİSİ R410A SCROLL KOMPRESÖRLER

Model	Kod No	Btu 50 Hz.	Disp. CC	Nominal Güç	Voltaj	Emme Basma		Çalışma Rejimi	Yağ Miktarı (Lt)	Fiyat
<b>SH 090 A4ALC</b>	120H0003	76.100	88,4	8,0 Hp	380 V / 400V 50Hz 460V 60Hz	11/8"	7/8"	+15°C / -30 °C (MBP)	3	<b>1.336,62 €</b>
<b>SH 105 A4ALC</b>	120H0211	91.500	103,5	9,0 Hp		13/8"	7/8"		3,3	<b>1.505,13 €</b>
<b>SH 120 A4ALC</b>	120H0013	102.400	116,9	10 Hp		13/8"	7/8"		3,3	<b>1.589,40 €</b>
<b>SH 140 A4ALC</b>	120H0201	118.400	132,9	12 Hp		13/8"	7/8"		3,3	<b>1.802,53 €</b>
<b>SH 161 A4ALC</b>	120H0023	132.400	151,7	13 Hp		13/8"	7/8"		3,3	<b>1.937,19 €</b>
<b>SH 184 A4ALC</b>	120H0361	152.600	170,3	15 Hp		15/8"	11/8"		6,7	<b>2.014,84 €</b>
<b>SH 240 A4ABE</b>	120H0299	203.800	227,6	20 Hp		15/8"	11/8"		6,7	<b>3.024,33 €</b>
<b>SH 295 A4ABE</b>	120H0827	249.800	276,5	25 Hp		15/8"	11/8"		6,7	<b>3.296,10 €</b>
<b>SH 380 A4ABE</b>	120H0255	308.900	345,0	30 Hp		15/8"	11/8"		6,7	<b>3.925,58 €</b>
<b>SH 485 A4ABA</b>	120H1064	397.300	442,6	40 Hp		15/8"	1 3/8"		6,7	<b>5.149,84 €</b>

\* Kompresörler kaynak bağlantılıdır. Karter ısıtıcısı 30,28 Euro'dur.



## DANFOSS MLZ SERİSİ R404A SCROLL KOMPRESÖRLER

Model Kod No	Evaporasyon	-25°C	-20°C	-15°C	-10°C	-5°C	-0°C	+5°C	+10°C
	Kondenzasyon								
<b>MLZ 015</b>	40°C	1.900	2.400	3.000	3.700	4.400	5.300	6.300	7.400
	50°C	-	1.800	2.400	2.900	3.600	4.300	5.100	6.000
<b>MLZ 019</b>	40°C	2.600	3.300	4.000	4.800	5.800	6.900	8.200	9.700
	50°C	-	2.700	3.300	4.000	4.800	5.800	6.800	8.100
<b>MLZ 021</b>	40°C	2.800	3.500	4.300	5.100	6.200	7.300	8.700	10.300
	50°C	-	2.900	3.500	4.300	5.100	6.100	7.300	8.600
<b>MLZ 026</b>	40°C	3.500	4.300	5.300	6.400	7.700	9.200	10.900	12.800
	50°C	-	3.600	4.400	5.300	6.400	7.700	9.100	10.700
<b>MLZ 030</b>	40°C	4.200	5.200	6.400	7.700	9.300	11.100	13.100	15.400
	50°C	-	4.300	5.300	6.400	7.700	9.200	11.000	12.900
<b>MLZ 038</b>	40°C	5.000	6.200	7.600	9.200	11.100	13.200	15.600	18.400
	50°C	-	5.100	6.300	7.700	9.200	11.000	13.100	15.400
<b>MLZ 045</b>	40°C	6.100	7.500	9.100	11.100	13.300	15.900	18.800	22.000
	50°C	-	6.200	7.600	9.200	11.100	13.200	15.700	18.500
<b>MLZ 048</b>	40°C	6.600	8.200	10.000	12.100	14.500	17.300	20.500	24.200
	50°C	-	6.800	8.300	10.100	12.100	14.400	17.100	20.300
<b>MLZ 058</b>	40°C	7.600	9.300	11.600	14.300	17.400	20.900	24.800	29.000
	50°C	-	7.100	9.000	11.300	14.000	17.000	20.300	23.900
<b>MLZ 066</b>	40°C	9.000	11.200	13.600	16.500	19.800	23.600	27.900	32.800
	50°C	-	9.200	11.400	13.800	16.600	19.700	23.300	27.400
<b>MLZ 076</b>	40°C	10.600	13.100	15.900	19.100	22.900	27.200	32.300	38.200
	50°C	-	11.000	13.000	15.400	18.300	21.800	25.900	30.800

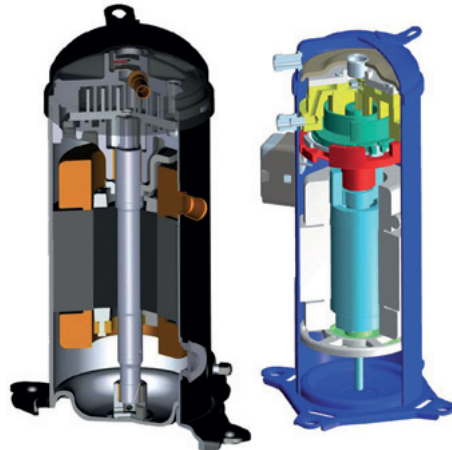

## DANFOSS MLZ SERİSİ BLUE R404A SCROLL KOMPRESÖRLER

Model	Kod No	Disp. CC	Normal Güç	Voltaj	Emme Basma		Gaz	Çalışma Rejimi	Yağ Miktarı (Lt)	Fiyat
<b>MLZ 015 T5LP9A</b>	121L8631	33,8	2,0 Hp	220 V 50HZ	3/4"	1/2"	R22 R407C R134A R404A	+10°C / -25 °C (MBP)	1,1	<b>602,27 €</b>
<b>MLZ 021 T5LP9A</b>	121L8635	46,2	3,0 Hp		3/4"	1/2"				<b>602,27 €</b>
<b>MLZ 030 T5LC9A</b>	121L8643	68,8	4,0 Hp		7/8"	1/2"				<b>717,91 €</b>
<b>MLZ 038 T5LC9A</b>	121L8647	81,0	5,0 Hp		7/8"	1/2"				<b>761,27 €</b>

<b>MLZ 015 T4LP9A</b>	121L8629	33,8	2,0 Hp	380 V / 400V 50Hz 460V 60Hz	3/4"	1/2"	R22 R407C R134A R404A	+10°C / -25 °C (MBP)	1,1	<b>551,68 €</b>
<b>MLZ 021 T4LP9A</b>	121L8633	46,2	3,0 Hp		3/4"	1/2"				<b>566,13 €</b>
<b>MLZ 026 T4LP9A</b>	121L8637	57,1	3,5 Hp		3/4"	1/2"				<b>623,95 €</b>
<b>MLZ 030 T4LC9A</b>	121L8641	68,8	4,0 Hp		7/8"	1/2"				<b>655,27 €</b>
<b>MLZ 038 T4LC9A</b>	121L8645	81,0	5,0 Hp		7/8"	1/2"			<b>708,25 €</b>	
<b>MLZ 045 T4LC9A</b>	121L8649	98,6	6,0 Hp		7/8"	1/2"			<b>758,85 €</b>	
<b>MLZ 048 T4LC9A</b>	121L8651	107,5	7,0 Hp		7/8"	3/4"			<b>876,89 €</b>	
<b>MLZ 058 T4LC9A</b>	121L8653	126,0	7,5 Hp		1 1/8"	7/8"			<b>1.019,03 €</b>	
<b>MLZ 066 T4LC9A</b>	121L8657	148,8	9,0 Hp		1 1/8"	7/8"			<b>1.175,62 €</b>	
<b>MLZ 076 T4LC9A</b>	121L8655	162,4	10 Hp		1 1/8"	7/8"			<b>1.233,44 €</b>	

\* Kompresörler kaynak bağlantılıdır. Vana takımı ve karter ısıtıcısı opsiyoneldir.

Karter Isıtıcı	230 V Tüm Modeller	<b>30,28 €</b>
----------------	--------------------	----------------

## DANFOSS LLZ SERİSİ LİKİT ENJEKSİYONLU SCROLL KOMPRESÖRLER R404A / R507 / R452A

Model	Kod No	m <sup>3</sup> /h	Nominal Güç	Voltaj	Gaz	Emme Basma	Çalışma Rejimi	Yağ Miktarı	Fiyat
LLZ 013 T4LQ9	121L9517	11,7	4 Hp	380 V / 400V 50HZ 460V 60HZ	R404A / R507 / R452A	1"1/4 & 7/8" 1" & 5/8"	-10°C / -40 °C (LBP)	1,62 Lt	1.087,96 €
LLZ 015 T4LQ9	121L9513	14,5	5 Hp						1.074,02 €
LLZ 018 T4LQ9	121L9509	17	6 Hp						1.195,88 €
LLZ 024 T4LQ9	121L9505	20,9	8 Hp			2,51 Lt		1.340,44 €	
LLZ 034 T4LQ9	121L9543	29,4	10 Hp					1.570,70 €	

### Aksesuarlar

### Fiyat

 Not: aksesuarlar kompresör fiyatına **Dahil değildir.**

- |                                      |                 |
|--------------------------------------|-----------------|
| 1) Likit Enjeksiyon Valfi TREV Y1037 | <b>189,29 €</b> |
| 2) Discharge Thermostat Kit 7750009  | <b>57,05 €</b>  |
| 3) Karter Isıtıcısı 220 V Ø185       | <b>30,28 €</b>  |

50 Hz, EN 12900 Superheat 10 K

\* Watt \*R404A

Model	Voltaj	Evap. Kond.	-40°C	-35°C	-30°C	-25°C	-20°C	-15°C	-10°C
			LLZ 013 T4LQ9	380 V / 400 V 50 Hz 460V 60 Hz	40°C	1.846	2.417	3.095	3.899
	50°C	-	1.915		2.483	3.154	3.949	4.885	5.987
LLZ 015 T4LQ9	40°C	2.267	2.937		3.754	4.745	5.936	7.353	9.025
	50°C	-	2.343		3.013	3.825	4.803	5.977	7.376
LLZ 018 T4LQ9	40°C	2.665	3.453		4.415	5.580	6.980	8.646	10.612
	50°C	-	2.755		3.543	4.497	5.648	7.029	8.673
LLZ 024 T4LQ9	40°C	3.405	4.411		5.639	7.127	8.915	11.044	13.555
	50°C	-	3.519		4.526	5.745	7.215	8.978	11.079
LLZ 034 T4LQ9	40°C	4.698	6.051		7.683	9.649	12.008	14.823	18.156
	50°C	-	4.755		6.099	7.702	9.622	11.920	14.660



Liquid injection system configuration

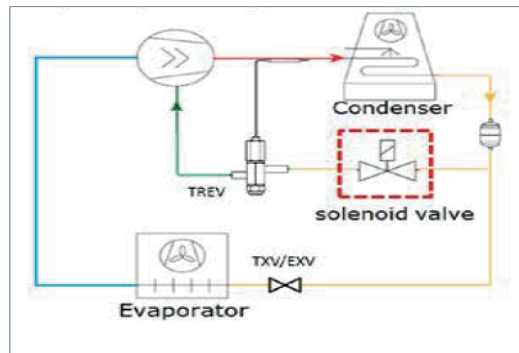

## DANFOSS NTZ SERİSİ R404A HERMETİK PİSTONLU KOMPRESÖRLER

Model	Kod No	Disp. CC	Nominal Güç	Voltaj	Vana Bağlantısı				Silindir Sayısı	Çalışma Rejimi	Yağ Miktarı (Lt)	Fiyat (Rotolok Bağlantılı)	
					Emme		Basma						
					Rot.	Çıkış	Rot.	Çıkış					
<b>NTZ 048</b>	120F0001	48	1,8 Hp	380 V / 400V 50HZ 460V 60HZ	11/4"	5/8"	1"	1/2"	-10°C / -45 °C (LBP)	0,95	<b>532,02 €</b>		
<b>NTZ 068</b>	120F0002	68	2,3 Hp			5/8"		1/2"			<b>583,24 €</b>		
<b>NTZ 096</b>	120F0003	96	3,5 Hp		13/4"	7/8"	11/4"	3/4"			2	1,8	<b>716,00 €</b>
<b>NTZ 108</b>	120F0004	108	3,75 Hp			7/8"		3/4"		<b>740,67 €</b>			
<b>NTZ 136</b>	120F0005	136	4,0 Hp			11/8"		3/4"		4		3,9	<b>760,58 €</b>
<b>NTZ 215</b>	120F0006	215	6,1 Hp			11/8"		3/4"					<b>1.251,83 €</b>
<b>NTZ 271</b>	120F0007	271	8,5 Hp		11/8"	3/4"	<b>1.396,92 €</b>						

\* Kompresör fiyatlarına vana ve karter ısıtıcısı dahil değildir. Kartar ısıtıcısı 30,28 Euro'dur.

\* Watt \*R404A

Model	-45°C	-40°C	-35°C	-30°C	-25°C	-20°C	-15°C	-10°C
<b>NTZ 048</b>	190	420	710	1.240	1.700	2.860	3.570	3.570
<b>NTZ 068</b>	520	870	1.290	2.110	2.785	4.490	5.540	5.540
<b>NTZ 096</b>	-	910	1.420	2.430	3.360	5.900	7.550	7.550
<b>NTZ 108</b>	-	1.120	1.770	3.010	4.080	6.800	8.530	8.530
<b>NTZ 136</b>	-	1.570	2.360	3.890	5.200	8.570	10.710	10.710
<b>NTZ 215</b>	1.190	2.240	3.540	5.970	8.030	13.220	16.420	16.420
<b>NTZ 271</b>	2.210	3.470	5.140	8.380	11.050	17.840	22.040	22.040

\* 45°C kondenzasyon

1/2"	Rotolok Bağlantı = 1"		<b>19,47 €</b>
5/8" - 3/4"	Rotolok Bağlantı = 1 1/4"		<b>29,62 €</b>
7/8" - 1 1/8"	Rotolok Bağlantı = 1 3/4"		<b>38,84 €</b>
Karter Isıtıcı	230 V Tüm Modeller		<b>30,28 €</b>



## DANFOSS MTZ SERİSİ HERMETİK PİSTONLU KOMPRESÖRLER KAPASİTE TABLOSU

Model Kod No	Voltaj	Evaporasyon	-30°C	-25°C	-20°C	-15°C	-10°C	-5°C	-0°C	+5°C	+10°C
		Kondenzasyon									
MTZ 18 4VI	380 V / 400 V 50 Hz 460 V 60 Hz	40°C	469	761	1.133	1.597	2.164	2.847	3.659	4.613	5.720
		50°C	313	546	839	1.203	1.651	2.195	2.848	3.623	4.531
MTZ 22 4VI		40°C	774	1.156	1.643	2.251	2.995	3.891	4.954	6.201	7.647
		50°C	515	809	1.187	1.665	2.259	2.985	3.857	4.892	6.106
MTZ 28 4VI		40°C	963	1.503	2.159	2.951	3.896	5.011	6.315	7.826	9.562
		50°C	570	1.012	1.546	2.193	2.969	3.892	4.982	6.254	7.728
MTZ 32 4VI		40°C	1.271	1.864	2.589	3.464	4.509	5.745	7.191	8.867	10.790
		50°C	828	1.308	1.893	2.603	3.457	4.476	5.979	7.085	8.715
MTZ 36 4VI		40°C	1.554	2.243	3.073	4.067	5.245	6.630	8.241	10.100	12.230
		50°C	1.046	1.624	2.311	3.125	4.089	5.225	6.552	8.093	9.868
MTZ 40 4VI		40°C	1.885	2.659	3.581	4.674	5.959	7.461	9.200	11.200	13.480
		50°C	1.314	1.968	2.734	3.635	4.693	5.930	7.370	9.033	10.940
MTZ 44 4VI		40°C	1.663	2.460	3.433	4.613	6.033	7.724	9.717	12.040	14.740
		50°C	1.062	1.735	2.543	3.517	4.689	6.090	7.753	9.708	11.990
MTZ 50 4VI		40°C	2.021	2.922	4.047	5.430	7.106	9.112	11.480	14.260	17.460
		50°C	1.390	2.108	2.997	4.093	5.432	7.050	8.981	11.260	13.930
MTZ 56 4VI		40°C	2.074	3.049	4.266	5.765	7.588	9.776	12.370	15.410	18.950
		50°C	1.414	2.205	3.182	4.386	5.859	7.643	9.778	12.310	25.270
MTZ 64 4VI		40°C	2.602	3.744	5.160	6.900	9.017	11.560	14.580	18.310	22.250
		50°C	1.730	2.667	3.813	5.224	6.950	9.043	11.550	14.530	18.030
MTZ 72 4VI	40°C	3.007	4.262	5.828	7.752	10.080	12.860	16.150	19.970	24.390	
	50°C	2.135	3.123	4.364	5.903	7.789	10.070	12.790	15.990	19.730	
MTZ 80 4VI	40°C	3.722	5.206	7.003	9.162	11.730	14.770	18.310	22.410	27.120	
	50°C	2.646	3.873	5.344	7.108	9.215	11.710	14.650	18.080	22.050	
MTZ 100 4VI	40°C	3.917	5.730	7.937	10.600	13.790	17.560	21.970	27.100	33.000	
	50°C	2.532	4.102	5.953	8.184	10.750	13.820	17.430	21.640	26.500	
MTZ 125 4VI	40°C	5.457	7.649	10.380	13.720	17.760	22.570	28.240	34.840	42.460	
	50°C	3.927	5.648	7.800	10.460	13.720	17.640	22.320	27.820	34.230	
MTZ 144 4VI	40°C	6.685	9.282	12.440	16.250	20.790	26.140	32.400	39.650	47.970	
	50°C	4.764	6.870	9.422	12.510	16.210	20.610	25.800	31.870	38.900	
MTZ 160 4VI	40°C	7.339	10.190	13.650	17.810	22.760	28.600	35.420	43.310	52.370	
	50°C	5.254	7.584	10.400	13.790	17.850	22.670	28.360	34.990	42.660	

\* Subcooling: 0°K, Superheat: 10°K





## DANFOSS MTZ SERİSİ HERMETİK PİSTONLU KOMPRESÖRLER R404A / R507 - R407C - R134A - R22 - R417A

Model Kod No	Disp. CC	Nominal Güç	Voltaj	Vana Bağlantısı				Silindir Sayısı	Çalışma Rejimi	Yağ Miktarı (Lt)	Fiyat (Rotolok Bağlantılı)
				Emme		Basma					
				Rot.	Çıkış	Rot.	Çıkış				
MTZ 18 5VI	30,23	1,5 Hp	220-230V 50 Hz.	1"	1/2"	1"	3/8"	1	+10 °C / -30 °C (MBP)	0,95	485,87 €
MTZ 22 5VI	38,12	2,0 Hp		1"	1/2"	1"	3/8"				499,79 €
MTZ 28 5VI	48,06	2,3 Hp		1"	5/8"	1"	1/2"				578,49 €
MTZ 32 5VI	53,86	2,7 Hp		1 1/4"	5/8"	1"	1/2"				603,15 €
MTZ 36 5VI	60,47	3,0 Hp		1 1/4"	5/8"	1"	1/2"				634,45 €

Fiyatlara elektrik kutusu dahil değildir.

Elektrik Kutusu	230 V Tüm Modeller	74,80 €
-----------------	--------------------	---------

Model Kod No	Disp. CC	Nominal Güç	Voltaj	Emme Rot.	Emme Çıkış	Basma Rot.	Basma Çıkış	Silindir Sayısı	Çalışma Rejimi	Yağ Miktarı (Lt)	Fiyat (Rotolok Bağlantılı)
MTZ 18 4VI	30,23	1,5 Hp	380 V / 400V 50Hz. 460V 60Hz.	1"	1/2"	1"	3/8"	1	+10 °C / -30 °C (MBP)	0,95	479,87 €
MTZ 22 4VI	38,12	1,8 Hp		1"	1/2"	1"	3/8"				499,79 €
MTZ 28 4VI	48,06	2,3 Hp		1"	5/8"	1"	1/2"				526,33 €
MTZ 32 4VI	53,86	2,7 Hp		1 1/4"	5/8"	1"	1/2"				548,15 €
MTZ 36 4VI	60,47	3,0 Hp		1 1/4"	5/8"	1"	1/2"				576,60 €
MTZ 40 4VI	67,89	3,5 Hp		1 1/4"	5/8"	1"	1/2"				618,32 €
MTZ 44 4VI	76,22	3,75 Hp		1 3/4"	7/8"	1 1/4"	3/4"	2	+10 °C / -30 °C (MBP)	1,8	697,99 €
MTZ 50 4VI	85,64	4,0 Hp		1 3/4"	7/8"	1 1/4"	3/4"				723,59 €
MTZ 56 4VI	96,13	4,6 Hp		1 3/4"	7/8"	1 1/4"	3/4"				763,43 €
MTZ 64 4VI	107,71	5,0 Hp		1 3/4"	7/8"	1 1/4"	3/4"				826,01 €
MTZ 72 4VI	120,94	6,0 Hp		1 3/4"	7/8"	1 1/4"	3/4"	4	+10 °C / -30 °C (MBP)	3,9	956,88 €
MTZ 80 4VI	135,78	6,5 Hp		1 3/4"	1 1/8"	1 1/4"	3/4"				977,74 €
MTZ 100 4VI	171,26	8,5 Hp		1 3/4"	1 1/8"	1 1/4"	3/4"				1.531,58 €
MTZ 125 4VI	215,44	10 Hp		1 3/4"	1 1/8"	1 1/4"	3/4"				1.816,08 €
MTZ 144 4VI	241,87	12 Hp		1 3/4"	1 1/8"	1 1/4"	3/4"	4	+10 °C / -30 °C (MBP)	3,9	1.891,95 €
MTZ 160 4VI	271,55	13 Hp		1 3/4"	1 1/8"	1 1/4"	3/4"				2.031,35 €

\* Kompresör fiyatlarına vana ve karter ısıtıcısı dahil değildir.

3/8" - 1/2" - 5/8"	Rotolok Bağlantı = 1"		19,47 €
5/8" - 3/4" - 7/8"	Rotolok Bağlantı = 1 1/4"		29,62 €
7/8" - 1 1/8" - 1 3/8"	Rotolok Bağlantı = 1 3/4"		38,84 €
1 5/8"	Rotolok Bağlantı = 2 1/4"		120,10 €
Karter Isıtıcı	230 V Tüm Modeller		30,28 €



## DANFOSS TİCARİ KOMPRESÖRLER

### R134a (\*) HMBP | HBP - 50 Hz

Model	Kod	Disp. (cm <sup>3</sup> )	Güç (hp)	App.	Voltaj	Motor	Soğutma Kapasitesi						Fiyat	
							W/W'da COP Evaporasyon Sıcaklığı °C							
							CECOMAF (W)				ASHRAE			
							-25	-15	5		10	7,2		
W	COP	W	COP											
GL 90TB	123B1533	8,85	1/4	HMBP	220-240V 50Hz	CSIR	143	259	660	1,90	796	787	2,20	<b>86,52 €</b>
GP 14TB	123B1712	14,17	3/8	HBP		CSIR	191	373	998	1,76	1208	1192	2,03	<b>97,97 €</b>
GP 16TB	123B1713	16,15	3/8	HBP		CSIR	-	476	1204	1,80	1451	1435	2,09	<b>122,15 €</b>
GPY 16RAa	123B1542	16,15	1/2	HMBP		CSIR	307	542	1317	2,02	1574	1564	2,34	<b>148,87 €</b>
GX 23TB	123B1547	23,2	3/4	HMBP		CSIR	368	677	1729	1,88	2082	2060	2,18	<b>203,58 €</b>
GS 34TB-V	123B1607	34,42	1	HMBP		CSR	476	1068	2850	2,26	3420	3407	2,62	<b>268,47 €</b>

### R404A - R507 HMBP | HBP - 50 Hz

Model	Kod	Disp. (cm <sup>3</sup> )	Güç (hp)	App.	Voltaj	Motor	Soğutma Kapasitesi						Fiyat	
							W/W'da COP Evaporasyon Sıcaklığı °C							
							CECOMAF (W)				ASHRAE			
							-25	-15	5		10	7,2		
W	COP	W	COP											
MPT 12RA	123B2518	12,1	3/8	HMBP	220-240V 50Hz	CSR	437	723	1559	1,91	1823	1950	2,35	<b>115,79 €</b>
MPT 14RA	123B2704	14,32	1/2	HBP		CSR	-	789	1750	1,78	2068	2199	2,20	<b>156,49 €</b>
MX 16TBa	123B2706	16,03	3/4	HMBP		CSR	481	814	1868	1,74	2212	2350	2,15	<b>192,12 €</b>
MX 21TBa	123B2708	20,72	1	HBP		CSR	621	1046	2410	1,74	2856	3032	2,15	<b>201,02 €</b>
MS 26TB-V	123B2536	25,93	1 3/8"	HMBP		CSR	671	1288	3164	2,00	3767	3991	2,46	<b>267,21 €</b>
MS 34TB-V	123B2712	34,42	1 5/8"	HBP		CSR	-	1850	4205	1,89	4930	5266	2,30	<b>263,36 €</b>
MS 34T3-V	123B2539	34,42	1 5/8"	HMBP	400/440V 50/60Hz	3 PHASE	1002	1850	4205	1,79	4930	5266	2,20	<b>277,37 €</b>

### R404A LBP - 50 Hz

Model	Kod	Disp. (cm <sup>3</sup> )	Güç (hp)	App.	Voltaj	Motor	Soğutma Kapasitesi						Fiyat	
							W/W'da COP Evaporasyon Sıcaklığı °C							
							CECOMAF (W)				ASHRAE			
							-40	-30	-25		-10	-23,3		
W	COP	W	COP											
ML 80FB	123B2111	8,1	1/4	LBP	220-240V 50Hz	CSIR	99	189	251	0,77	505	371	1,09	<b>104,33 €</b>
ML 90FB	123B2115	8,85	1/3	LBP		CSIR	104	207	275	0,83	548	407	1,16	<b>109,42 €</b>
MLY 12LAa	123B2119	10,7	3/8	LBP		CSR	156	294	387	0,94	762	570	1,33	<b>118,33 €</b>
MP 14FB	123B2124	14,17	1/2	LBP		CSIR	121	304	421	0,79	877	625	1,12	<b>123,41 €</b>
MPT 14LA	123B2126	14,32	1/2	LBP		CSR	242	419	534	0,99	984	775	1,38	<b>161,58 €</b>
MPT 16LA	123B2127	16,15	1/2	LBP		CSR	245	462	605	1,00	1168	885	1,40	<b>171,76 €</b>
MX 23FBa	123B2132	23,2	3/4	LBP		CSR	259	534	718	0,96	1455	1064	1,35	<b>216,32 €</b>
MS 34FB-V	123B2172	34,42	1	LBP		CSR	242	759	1083	0,95	2311	1625	1,35	<b>258,29 €</b>

## DANFOSS BOCK YARI-HERMETİK KOMPRESÖRLER

Model	Kod	Disp. (m <sup>3</sup> /h)	Motor Gücü (hp)	Tc	Soğutma Kapasitesi (Qo) (kW) (R404A)							Fiyat
					Te	0°C	-5°C	-10°C	-15°C	-20°C	-25°C	
HGX12P/60-4S		5,4	2	40°C	4,2	3,43	2,77	2,2	1,71	1,3	0,959	
				50°C	3,4	2,75	2,2	1,73	1,33	0,994	0,722	
HGX12P/75-4S		6,7	2,5	40°C	5,31	4,38	3,57	2,87	2,27	1,76	1,33	
				50°C	4,35	3,57	2,89	2,31	1,81	1,39	1,05	
HGX12P/90-4S		8	3	40°C	6,35	5,42	4,28	3,45	2,73	2,13	1,63	
				50°C	5,22	4,29	3,48	2,79	2,2	1,71	1,3	
HGX12P/110-4S		9,4	3	40°C	7,37	6,1	4,99	4,03	3,21	2,5	1,91	
				50°C	6,01	4,94	4,02	3,23	2,55	1,98	1,49	
HGX22e/125-4S		11,1	3	40°C	8,97	7,44	6,08	4,87	3,81	2,89	2,12	
				50°C	7,39	6,07	4,9	3,87	2,98	2,23	1,61	
HGX22e/160-4S	097C2796	13,7	4,1	40°C	11,2	9,25	7,51	5,98	4,65	3,51	2,57	1.439,00 €
				50°C	9,15	7,49	6,01	4,73	3,62	2,7	1,94	
HGX22e/190-4S	097C2811	16,5	4,1	40°C	13,7	11,4	9,27	7,49	5,95	4,64	3,54	1.492,00 €
				50°C	11,3	9,24	7,51	6,02	4,74	3,65	2,75	
HGX34e/215-4S	097C3049	18,8	5	40°C	15,3	12,5	9,99	7,91	6,13	4,64	3,41	1.697,00 €
				50°C	12,2	9,84	7,82	6,11	4,68	3,49	2,52	
HGX34e/255-4S	097C3074	22,1	6	40°C	18,1	14,8	11,9	9,42	7,29	5,51	4,04	1.580,00 €
				50°C	14,6	11,8	9,4	7,35	5,61	4,17	3,01	
HGX34e/315-4S	097C3109	27,3	7	40°C	22	18,1	14,8	11,9	9,32	7,18	5,37	1.786,00 €
				50°C	17,8	14,6	11,8	9,37	7,29	5,53	4,04	
HGX34e/380-4S	097C3152	33,1	9	40°C	26,7	22,2	18,2	14,8	11,8	9,16	6,98	2.038,00 €
				50°C	21,8	18	14,7	11,8	9,33	7,21	5,39	
HGX44e/475-4S	097C3567	41,3	12	40°C	34,6	28,6	23,4	18,9	15,1	11,9	9,03	2.621,00 €
				50°C	28,5	23,4	19	15,2	12,1	9,3	6,98	

Tüm kompresörlerde; Yağ karter ısıtıcısı 110-240V AC

HGX44 ve üzeri modellerde; Yağ karter ısıtıcısı + Delta-P II Yağ basınç sensörü. **Fiyata dahildir.**

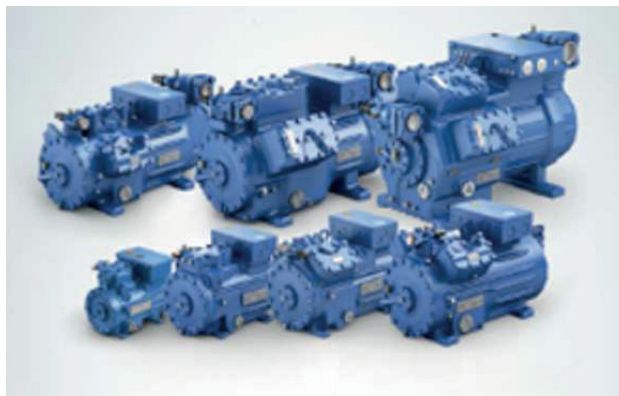

## DANFOSS BOCK YARI-HERMETİK KOMPRESÖRLER

Model	Kod	Disp. (m³/h)	Motor Gücü (hp)	Tc	Soğutma Kapasitesi (Qo) (kW) (R404A)							Fiyat
				Te	0°C	-5°C	-10°C	-15°C	-20°C	-25°C	-30°C	
HGX44e/565-4S	097C3624	49,2	15	40°C	41,4	34,3	28,2	22,9	18,3	14,4	11,1	2.831,00 €
				50°C	34,2	28,2	23	18,5	14,7	11,5	8,66	
HGX44e/665-4S	097C3686	57,7	20	40°C	47,9	39,6	32,4	26,2	20,9	16,4	12,5	3.222,00 €
				50°C	39,3	32,3	28,2	21	16,6	12,8	9,59	
HGX44e/770-4S	097C3748	67	22	40°C	55,6	46,1	37,8	30,7	24,5	19,3	14,9	3.666,00 €
				50°C	45,7	37,6	30,7	24,7	19,6	15,3	11,8	
HGX56e/850-4S	097C2586	73,8	25	40°C	61,7	51,2	42	34,1	27,3	21,8	16,6	4.091,00 €
				50°C	50,9	41,9	34,2	27,6	22	17,1	13	
HGX56e/995-4S	097C2627	86,6	30	40°C	72,5	60,1	49,2	39,8	31,6	24,5	18,5	4.535,00 €
				50°C	59,4	48,9	39,7	31,8	25	19,1	14,1	
HGX56e/1155-4S	097C2681	100,4	35	40°C	83,5	69,1	56,7	46	36,8	29	22,3	4.697,00 €
				50°C	68,7	56,5	46	37,1	29,4	22,9	17,4	
HGX66e/1340-4S	097C1012	116,5	37	40°C	98,8	81,9	67,1	54,3	43,1	33,6	25,5	5.837,00 €
				50°C	80,7	66,5	54,2	43,5	34,3	26,5	19,9	
HGX66e/1540-4S	097C1095	133,8	42	40°C	114	94,3	77,5	62,8	50,2	39,3	30	6.393,00 €
				50°C	92,9	76,8	62,7	50,6	40,1	31,2	23,6	
HGX66e/1750-4S	097C1177	152,2	50	40°C	129	108	88,1	71,4	57,1	44,7	34,2	7.034,00 €
				50°C	106	87,2	71,3	57,5	45,7	35,6	27	
HGX66e/2070-4S		180	60	40°C	152	126	104	84	67,2	52,7	40,3	
				50°C	124	103	83,6	67,6	53,8	41,9	31,8	
HGX88e/2400-4S		209,1	70	40°C	181	150	124	99,8	79,7	62,4	47,7	
				50°C	149	123	99,9	80,5	63,9	49,8	37,7	
HGX88e/2735-4S		237,9	80	40°C	205	170	140	114	90,5	70,9	54,2	
				50°C	168	139	114	91,4	72,6	56,5	42,8	
HGX88e/3235-4S		281,3	95	40°C	242	201	165	134	107	83,4	63,6	
				50°C	199	164	134	108	85,3	66,3	50,2	

Model	Kod	Disp. (m³/h)	Motor Gücü (hp)	Tc	Soğutma Kapasitesi (Qo) (kW) (R404A)							Fiyat
				Te	-30°C	-35°C	-40°C	-45°C	-50°C	-55°C	-60°C	
HGZX7/1620-4	097C2122	93,7	25	40°C	33,5	27,4	22,2	18	14,4	11,5	9,05	9.250,00 €
				50°C		25,9	21	16,9	13,5	10,7	8,34	
HGZX7/1860-4	097C2135	107,6	30	40°C	38,4	31,4	25,5	20,6	16,6	13,2	10,4	9.500,00 €
				50°C		29,7	24,1	19,4	15,5	12,3	9,57	
HGZX7/2110-4		122,4	45	40°C	43,7	35,7	29	23,4	18,8	15	11,9	
				50°C	199	33,8	27,4	22,1	17,7	14	10,9	

Tüm kompresörlerde; Yağ karter ısıtıcısı 110-240V AC

HGX44 ve üzeri modellerde; Yağ karter ısıtıcısı + Delta-P II Yağ basınç sensörü.

Çift kademe modellerde; Yağ karter ısıtıcısı 110-240V AC+Delta-P II Yağ basınç sensörü + Ekonomizer

**Fiyata dahildir.**

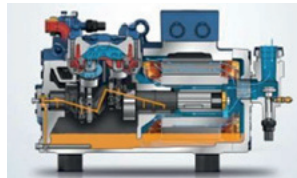

## DANFOSS COLIBRI ELECTRONIC EXPANSION VALFLER ETS 12C - 24C - 25C - 50C - 100C

### ÖZELLİKLER:

- \* Heat Pump uyumlu
- \* Doğrudan tahrikli motor
- \* Adımlı motor
- \* Çok hızlı açma ve kapama süresi
- \* Akış regülasyonunu hassas kontrol edebilen 2 kutuplu güçlü motor
- \* Tam kapanma özelliği sayesinde solenoid valfe ihtiyaç duyulmaz
- \* Gözetleme camlı modellerde nem göstergesi
- \* Buharlaştırmayacağı kadar likit geçişine izin vermez
- \* Çift yönlü yüksek ve tam likit geçişi



**Çok Çevik, Çok Hızlı**

### ELECTRONIC EXPANSION VALF

Model	Kod No	Kapasite R407C Kw	Kapasite R22 Kw	Kapasite R134a Kw	Kapasite R404A Kw	Kapasite R410a Kw	Bağlantı Çapı (Ø)	Fiyat
ETS 12C	034G7501	95,1	85,41	68,0	66,49	105,3	5/8" - 5/8"	203,58 €
ETS 12C	034G7502	95,1	85,41	68,0	66,49	105,3	7/8" - 7/8"	203,58 €
ETS 24C	034G7902	165,1	148,3	118,1	115,5	182,8	7/8" - 7/8"	227,52 €
ETS 25C	034G7602	165,1	148,3	118,1	115,5	182,8	7/8" - 7/8"	335,30 €
ETS 50C	034G7701	313,5	281,6	224,3	219,2	347,1	7/8" - 1 1/8"	384,22 €
ETS 50C	034G7702	313,5	281,6	224,3	219,2	347,1	1 1/8"-1 1/8"	384,22 €
ETS 100C	034G7802	615,6	552,9	440,3	430,4	681,5	1 3/8"-1 3/8"	455,05 €

### SUPERHEAT CONTROL (0,5 - 4,5V / 0-10V / 1-5V / 0-20mA )

Model	Kod No		Fiyat
EKE 1A	080G5300	Superheat Kontrolörü	233,99 €
EKE 1B	080G5350	Superheat Kontrolörü (Modbus)	257,29 €
EKE 1C	080G5400	Superheat Kontrolörü (Modbus + Canbus)	388,41 €
MMIGRS 2	080G0294	Harici Ekran	207,71 €
RJ 12	080G9744	MMIGRS Kablo 2 Mt. (RJ 12 Soketli)	10,86 €
AKS 32R	060G6323	(0-5v -1/12 bar) Basınç Transmitter 1/4" Dişi	154,17 €
AKS 33	080G2044	(4-20 Ma -1/9 bar) Basınç Transmitter	123,32 €
M 12	034G2201	Expansion Driver Arası Bağlantı Kablosu	60,98 €
DSTP 110	075G4002	(0-5v -1/12 bar) Basınç Transmitter	53,50 €
DSTP 110	075G4007	(0-5v -1/34 bar) Basınç Transmitter	53,50 €
DSTP 110	075G4009	(0-5v 0/50 bar) Basınç Transmitter	61,00 €
NSK-PP 13	061H5177	Transmitter Kablosu	14,59 €
S2 SENS	B49-P36-285	NTC 10k Isı Sensörü (Metal Uçlu)	7,82 €
NTC 10K	B49-P36-284	NTC 10k Prob 1,5 Mt. (-50/+50)	4,84 €
AKS 11	084N0028	PT 1000 Sensör 5,5 Mt. (S2 - S4)	29,64 €
ACCPBT	080G0210	PT 1000 Sensör 6 Mt.	27,65 €

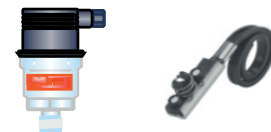



## DANFOSS ETS 6 ELECTRONIC EXPANSION VALFLER

### ÖZELLİKLER:

- \* Full hermetik dizayn
- \* Sistem için optimize edilmiş enerji verimliliği
- \* Yüksek çözünürlüklü hassas akış kontrolü
- \* Kompakt ve hafif
- \* Kanıtlanmış yüksek güvenilirlik
- \* Heat Pump uygulamaları için iki yönlü akış imkanı
- \* Buharlaştırmayacağı kadar likit geçişine izin vermez
- \* EIM336 ve EKD-316 ile kullanabilme özelliği



### ELECTRONIC EXPANSION VALF

Model	Kod No	Kapasite R407C Kw	Kapasite R22 Kw	Kapasite R134a Kw	Kapasite R404A Kw	Kapasite R410a Kw	Bağlantı Çapı (Ø)	Fiyat
ETS 6-10	034G5005	2,7	2,6	2,0	1,8	3,1	5/16" - 5/16"	40,78 €
ETS 6-14	034G5015	5,9	5,8	4,5	4,1	6,8	5/16" - 5/16"	50,19 €
ETS 6-18	034G5026	10,6	10,3	8,1	7,3	12,1	1/4" - 1/4"	62,73 €
ETS 6-25	034G5035	20,1	19,6	15,3	13,8	23,0	5/16" - 5/16"	77,37 €
ETS 6-32	034G5055	29,6	28,8	22,5	20,3	33,9	5/16" - 5/16"	96,19 €
ETS 6-40	034G5065	40,2	39,1	30,6	27,6	46,0	5/16" - 5/16"	110,83 €
ETS-6 Bobin	034G5105	(0,7mt kablo uzunluğu) JST XHP-6						24,40 €
ETS-6 Bobin	034G5115	(0,7mt kablo uzunluğu) JST XHP-5						24,40 €
ETS 12,5	034G4210	63	57	45	43	70	5/8" - 5/8"	279,69 €
ETS 25	034G4203	129	117	93	88	144	7/8" - 7/8"	332,84 €
ETS 50	034G1705	240,5	215	170	161,4	262,3	7/8" - 1 1/8"	418,21 €
ETS 100	034G0501	447,8	400,4	316,5	300,5	488,4	1 1/8" - 1 3/8"	461,78 €
ETS -250	034G2602	1.212	1.106	874	828	-	1 5/8"-1 5/8"	709,23 €
ETS 400	034G3500	1.933	1.764	1.394	1.320	-	1 5/8"-1 5/8"	911,36 €

### SUPERHEAT CONTROL

Model	Kod No		Fiyat
EIM 336	080G1002	Superheat Controller (MODBUS)	111,79 €
Kablo Seti	080G1601	Konnektör Kit	54,99 €
AKS 32R	060G6323	(0-5V -1/12Bar) Basınç Transmitter 1/4" Dişi	154,17 €
AKS 32R	060G1036	(0-5V -1/12Bar) Basınç Transmitter 1/4" Erkek	154,17 €
AKS 11	084N0028	Isı Sensörü (S2 - S4)	29,64 €
M12	034G2201	Expansion Driver Arası Bağlantı Kablosu	60,98 €



\* Fiyatlara bobin dahil değildir.



## ELECTRONIC EXPANSION VALF

### AKV 10P

Model	Kod No	R744				R470A/R507		R404A		Paket Miktarı	Fiyat
		Soğuk Muhfaza (kW)	Donmuş Muhfaza (kW)	Soğuk Muhfaza (TR)	Donmuş Muhfaza (TR)	kW	TR	kW	TR		
<b>AKV 10P1</b>	068F5211	1,17	1,84	0,33	0,52	0,9	0,26	0,64	0,18	18	<b>113,27 €</b>
<b>AKV 10P2</b>	068F5212	2,06	3,25	0,58	0,92	1,58	0,45	1,12	0,32	18	<b>113,27 €</b>
<b>AKV 10P3</b>	068F5213	3,14	4,97	0,89	1,41	2,41	0,69	1,72	0,49	18	<b>113,27 €</b>
<b>AKV 10P4</b>	068F5214	6,10	9,64	1,74	2,74	4,68	1,33	3,33	0,95	18	<b>113,27 €</b>
<b>AKV 10P5</b>	068F5215	8,49	13,41	2,41	3,81	6,52	1,86	4,64	1,32	18	<b>113,27 €</b>
<b>AKV 10P6</b>	068F5216	15,14	23,90	4,30	6,80	11,60	3,30	8,27	2,35	18	<b>113,27 €</b>
<b>AKV 10P7</b>	068F5217	24,58	38,80	6,99	11,03	18,81	5,35	13,40	3,82	18	<b>113,27 €</b>

### AKV Bobin

Kod No	Özellikler	Paket Miktarı	Fiyat
018F6802	240 V a.c. 12W, 50 Hz	24	<b>29,63 €</b>
018F6905	230V a.c. 20 W, 50 Hz	24	<b>41,83 €</b>

### AKVH 10

Model	Kod No	R744 (CO <sub>2</sub> )		Paket Miktarı	Fiyat
		Soğuk Muhafaza	Donmuş Muhafaza		
<b>AKVH 10-0</b>	068F4078	0,4 kW	0,8 kW	18	<b>139,40 €</b>
<b>AKVH 10-1</b>	068F4079	1,1 kW	2,2 kW	18	<b>139,40 €</b>
<b>AKVH 10-2</b>	068F4080	1,7 kW	3,5 kW	18	<b>139,40 €</b>
<b>AKVH 10-3</b>	068F4081	2,6 kW	5,4 kW	18	<b>139,40 €</b>
<b>AKVH 10-4</b>	068F4082	4,3 kW	8,7 kW	18	<b>139,40 €</b>
<b>AKVH 10-5</b>	068F4083	6,7 kW	13,6 kW	18	<b>139,40 €</b>
<b>AKVH 10-6</b>	068F4084	10,7 kW	21,7 kW	18	<b>139,40 €</b>





\* Fiyatlara bobin dahil değildir.

### AKV 10

Model	Kod No	Nominal Kapasite - [Te: +5°C Tc: +32°C]				Paket Miktarı	Fiyat
		R22/R407C	R134a	R404A/R507	R407C		
<b>AKV 10-2</b>	068F1164	1,6 kW	1,4 kW	1,3 kW	1,7 kW	18	<b>113,27 €</b>
<b>AKV 10-4</b>	068F1170	4,1 kW	3,4 kW	3,1 kW	4,0 kW	18	<b>113,27 €</b>
<b>AKV 10-5</b>	068F1173	6,4 kW	5,3 kW	4,9 kW	6,4 kW	18	<b>113,27 €</b>



## DANFOSS MCX PROGRAMLANABİLİR KONTROL CİHAZLARI

Model	Analog Giriş	Röle Sayısı	Analog Çıkış	Dijital Giriş	Özellikler	Fiyat
<b>MCX06C</b>	<b>4 ad.</b> 2 ad. Ntc 0/1V,0/5V 2 ad. Ntc, PT1000,0/1V, 0/5V,0/10V,0/20ma, 4-20 ma, On/Off	<b>6 ad.</b> Spst: 6 ad. 5 Amp	<b>2 ad.</b> 1 ad. 0/10Vdc, PWM, PPM 1 ad. PWM, PPM cutting phase	<b>6 ad.</b> Serbest Voltaj		<b>Fiyat Sorunuz</b>
<b>MCX06D</b>	<b>4 ad.</b> 2 ad. Ntc 0/1V, 0/5V 2 ad. Ntc,PT1000,0/1V, 0/5V,0/10V,0/20 ma, 4-20 ma, On/Off	<b>6 ad.</b> Spst: 5a d. 8 Amp Spdt: 1 ad. 8 Amp	<b>3 ad.</b> 2 ad. 0/10Vdc, PWM, PPM 1ad. PWM, PPM	<b>8 ad.</b> Serbest Voltaj		<b>Fiyat Sorunuz</b>
<b>MCX061V</b>	<b>7 ad.</b> 3 ad. NTC, Pt1000, 0/1V, 0/5V, 0/10V, ON/ OFF, 0/20mA, 4/20mA, 2 ad. NTC, 0/1V, 0/5V, 0/10V, ON/OFF, 0/20mA, 4/20mA, Superheat S1: 0/1V, 0/5V, 0/10V, ON/OFF, 0/20m A, 4/20m A, S2: PT1000, 0/1V, 0/5V, 0/10V, ON/OFF,	<b>6 ad.</b> Spst : 6 ad. 5 Amp	<b>3 ad.</b> 2 ad. 0/10Vdc 1 ad. 0/10Vdc, PWM, PPM	<b>8 ad.</b> Serbest Voltaj		<b>Fiyat Sorunuz</b>
<b>MCX08M2</b>	<b>8 ad.</b> 4 ad. NTC 0/1 V, 0/5 V 4 ad. NTC, Pt1000, 0/1V, 0/5V, 0/10V, ON/OFF, 0/20mA, 4/20mA,	<b>8 ad.</b> Spst: 2 ad. 8 Amp Spdt: 4 ad. 8 Amp Spst: 2 ad. 16 Amp	<b>4 ad.</b> 2 ad. 0/10Vdc optoisolated 2 ad. PWM, PPM cutting phase	<b>8 ad.</b> Serbest Voltaj	Stepper elektronik expansion valf kontrolü 	<b>Fiyat Sorunuz</b>
<b>MCX15B2</b>	<b>10 ad.</b> 4 ad. NTC 0/1 V, 0/5 V, 0/10 V, NTC Table, PT1000 6 ad. NTC, Pt1000, Ni1000, 0/1V, 0/5V, 0/10V, ON/OFF, 0/20mA, 4/20mA	<b>15 ad.</b> Total current 65A SPDT Relay 16A 2 ad. (changeover) SPST Relay 5A 13 ad. (normally open)	<b>6 ad.</b> A01-A06 6 ad. 0/10Vdc galvanically isolated, A05-A06 2 ad. Asynchronous PWM,	<b>22 ad.</b> 4 ad. 24V optoisolated 4 ad. 230V Optoisolated		<b>Fiyat Sorunuz</b>
<b>MCX152V</b>	<b>14 ad.</b> 8 ad. NTC, Pt1000, 0/1 V, 0/5 V, 0/10 V, 0/20 mA, 4/20 mA, 6 ad. NTC, 0/1 V, 0/5 V, 0/10 V, 0/20 mA, 4/20 mA, 2 ad. Superheat S1: 0/1 V, 0/5 V, 0/10 V, 0/20 mA, 4/20 mA 2 ad. Superheat S2: PT1000, 0/1 V, 0/5 V, 0/10 V,	<b>15 ad.</b> 12 ad. SPST relay 5A 3 ad. SPDT relay 16A	<b>6 ad.</b> 0/10Vdc 2 ad. 0/10V, PWM, PPM	<b>18 ad.</b> 16 ad. Voltage free contact 2 ad. 24 V optoisolated 2 ad. 230 Vac optoisolated		<b>Fiyat Sorunuz</b>
<b>MCX20B2</b>	<b>16 ad.</b> 6ad. NTC 0/1 V, 0/5 V, 0/10 V, NTC Table, PT1000 10 ad. NTC, Pt1000, Ni1000, 0/1V, 0/5V, 0/10V, ON/OFF, 0/20mA, 4/20mA	<b>20 ad.</b> Total current 65A SPDT Relay 16A 2 ad. (changeover) SPST Relay 5A 18 ad. (normally open)	<b>6 ad.</b> A01-A06 6 ad. 0/10Vdc galvanically isolated, A05-A06 2 ad. Asynchronous PWM,	<b>22 ad.</b> 4 ad. 24V optoisolated 4 ad. 230V Optoisolated	2ad. Stepper elektronik expansion valf kontrolü 	<b>Fiyat Sorunuz</b>

- Merkezi sistem kontrolü
- Vidalı, pistonlu kapasite ve sistem kontrolü
- Chiller - Heatpump sistemleri
- Klima Santrali Kontrolü
- Havuz nem alma sistemleri
- Paket hijyenik ve hijyenik klima santrali sistem kontrolü
- Isı geri kazanım cihaz kontrolü
- Her türlü soğutma uygulamaları için yazılım.

## DANFOSS TERMOSTATLAR

Model	Kod No	Sensör Tipi	Röle Çıktıları	Dijital Giriş	Özellikler	Fiyat
<b>ERC 211</b>	080G3454	NTC 5K NTC 10K PT 1000 PTC	1	2AI, 1AI DI, 1DI	Soğutma uygulamaları (normal- orta-düşük sıcaklık) Gündüz- gece modu 16Amp röle	<b>30,76 €</b>
<b>ERC 213</b>	080G3458		3			<b>36,81 €</b>
<b>ERC 214</b>	080G3463		4			<b>42,59 €</b>
<b>AK-RC 204B</b>	080Z5001	OPTYMA KONTROL			230V AC	<b>154,47 €</b>
<b>NTC ISI SENSÖRÜ</b>		NTC (10K)	-50°C/110°C	1,5 Mt.		<b>4,70 €</b>
<b>NTC ISI SENSÖRÜ</b>		NTC (10K)	-50°C/110°C	3,5 Mt.		<b>6,12 €</b>
<b>NTC ISI SENSÖRÜ (Metal Uçlu)</b>		NTC (10K)	-50°C/110°C	1,5 Mt.		<b>7,60 €</b>

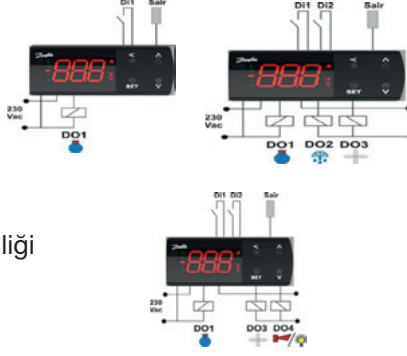

- \* Gündüz gece modu ile enerji verimliliği
- \* Kolay menü (4 buton)
- \* Hazır kullanıma hazır programlar.
- \* Vidalı (soketsiz) elektriksel terminal.

## DANFOSS MEKANİK TERMOSTATLAR

Kod No	Açıklama	Fiyat
077B7100	Vitrin	<b>7,00 €</b>
077B7101	Sebil / Dikey Soğutucu / Havuz	<b>7,00 €</b>
077B7102	Derin Dondurucu	<b>7,00 €</b>





## KELLER TRANSMITTER







Model	Kod No	Sinyal Tipi	Basınç Aralığı	Özellikler	Fiyat
<b>PA-21Y</b>	222155.0490	4-20mA	0 - 18 Bar	 -40 - 100°C çalışma aralığı 4pin M12 7/16"-20UNF dışı bağlantı	<b>57,50 €</b>
<b>PA-21Y</b>	222155.0026	4-20mA	0 - 30 Bar		<b>57,50 €</b>
<b>PA-21Y</b>	222155.2056	4-20mA	0 - 50 Bar		<b>57,50 €</b>
<b>PA-21C</b>	222120.0173	0-5 V ratio	-1 - 12 Bar		<b>61,75 €</b>
<b>PA-21C</b>	222120.0206	0-5 V ratio	-1 - 30 Bar		<b>61,75 €</b>
<b>PA-21C</b>	222120.0297	0-5 V ratio	0 - 30 Bar		<b>61,75 €</b>
<b>M12 Kablo</b>	6140500	---	---	5 mt. 4 x 0,34 Dişi	<b>15,25 €</b>

## SENSÖRLER VE AKSESUARLAR

### ISI SENSÖRLERİ

Model	Kod No	Sinyal Tipi	Çalışma Aralığı	Kablo Uzunluğu	Özellikler	Fiyat
<b>AK-HS 1000</b>	084N1007	PT 1000	-30°C / 50°C	5,5 Mt		<b>71,94 €</b>
<b>AKS 21 D</b>	084N2035	PT 1000	-40°C / 80°C	-		<b>467,61 €</b>
<b>EKS 221</b>	084N3200	NTC (10K)	-50°C / 110°C	1,5 Mt		<b>10,54 €</b>

### BASINÇ SENSÖRLERİ

Model	Kod No	Sinyal Tipi	Çalışma Aralığı	Bağlantı Tipi	Özellikler	Fiyat
<b>AKS 32</b>	060G2069	0-5V	-1/12 Bar	1/4" Erkek		<b>213,78 €</b>
<b>AKS 32</b>	060G2155	0-5V	-1/50 Bar	1/4" Erkek		<b>213,78 €</b>
<b>AKS 33</b>	060G2044	4-20ma	-1/9 Bar	1/4" Erkek		<b>123,32 €</b>
<b>AKS 33</b>	060G2045	4-20ma	0/25 Bar	1/4" Erkek		<b>123,32 €</b>
<b>AKS 3000</b>	060G1007	4-20ma	-1/9 Bar	1/4" Erkek		<b>213,78 €</b>
<b>AKS 3000</b>	060G1325	4-20ma	0/18 Bar	1/4" Erkek		<b>213,78 €</b>
<b>AKS 3000</b>	060G1327	4-20ma	0/30 Bar	1/4" Erkek		<b>152,29 €</b>
<b>AKS 3000</b>	060G1328	4-20ma	0/40 Bar	1/4" Erkek		<b>136,08 €</b>
<b>AKS 32R</b>	060G6323	0-5V	-1/12 Bar	1/4" Dişi		<b>154,17 €</b>
<b>AKS 32R</b>	060G1036	0-5V	-1/12 Bar	1/4" Erkek		<b>154,17 €</b>
<b>AKS 32R</b>	060G0090	0-5V	-1/34 Bar	1/4" Erkek		<b>154,17 €</b>

## PRESOSTATLAR

Model	Kod No	Paket Miktarı	Özellikler	Fiyat
<b>KP 1</b>	060-110166	36	Alçak basınç presostatı, otomatik reset -0,2/7,5 bar	<b>30,50 €</b>
<b>KP 1</b>	060-110366	36	Alçak basınç presostatı, manuel reset -0,2/7,5 bar	<b>29,62 €</b>
<b>KP 5</b>	060-117166	36	Yüksek basınç presostatı, otomatik reset 8 / 32 bar	<b>36,59 €</b>
<b>KP 5</b>	060-117366	36	Yüksek basınç presostatı, manuel reset 8 / 32 bar	<b>38,34 €</b>
<b>KP 6W</b>	060-519066	36	Yüksek basınç presostatı, otomatik reset 8 / 42 bar	<b>78,41 €</b>
<b>KP 6B</b>	060-519166	36	Yüksek basınç presostatı, manuel reset 8 / 42 bar	<b>78,41 €</b>
<b>KP 15</b>	060-124166	24	Alçak - Yüksek basınç presostatı, otomatik reset ve tek sinyalli	<b>59,25 €</b>
<b>KP 15</b>	060-124366	24	Alçak - Yüksek basınç presostatı, manuel reset ve tek sinyal	<b>60,98 €</b>
<b>KP 15</b>	060-126566	24	Alçak - Yüksek basınç presostatı, otomatik reset ve çift sinyalli	<b>60,98 €</b>
<b>KP 15</b>	060-126466	24	Alçak - Yüksek basınç presostatı, manuel reset ve çift sinyalli	<b>67,97 €</b>
<b>MP 54</b>	060-126466	24	Alçak - Yüksek basınç presostatı, manuel reset ve çift sinyal	<b>147,81 €</b>
<b>MP 55</b>	060B016766	21	Yağ basınç presostatı 60 SN $\Delta p= 0,9$ bar (sabit)	<b>168,94 €</b>
<b>MP 55</b>	060B017166	21	Yağ basınç presostatı 60 SN $\Delta p= 0,3 - 4,5$ bar	<b>168,94 €</b>
<b>MP 55</b>	060B017366	21	Yağ basınç presostatı 120 SN $\Delta p= 0,3 - 4,5$ bar	<b>168,94 €</b>
<b>RT 200L</b>	017L003266	15	Alçak basınç presostatı 0,2/ 6 bar (Ölü bölge)	<b>212,51 €</b>
<b>RT 117L</b>	017L004266	15	Yüksek basınç presostatı 10/ 30 bar (Ölü bölge)	<b>349,84 €</b>
<b>KP 35</b>	060-113366	36	Basınç presostatı -0,2/7,5 bar	<b>26,99 €</b>
<b>KP 36</b>	060-110866	36	Basınç presostatı 2/14 bar	<b>26,99 €</b>
<b>RT116</b>	017-520366	12	Basınç presostatı 1/10 bar	<b>109,50 €</b>

## MEKANİK TERMOSTATLAR

Model	Kod No	Paket Miktarı	Özellikler	Fiyat
<b>UT 72</b>	060H1103	24	İşletme Termostatı -30°C / +30°C	<b>50,54 €</b>
<b>RT 3</b>	017-501466	15	Oda Termostatı -25°C / +15°C	<b>172,41 €</b>
<b>RT 17</b>	017-511766	15	Oda Termostatı -50°C / +15°C	<b>169,42 €</b>
<b>RT 140</b>	017-523666	9	İşletme Termostatı +45°C / +15°C	<b>201,49 €</b>
<b>KP 61</b>	060L110066	32	Mekanik Termostat -30°C / +15°C	<b>46,19 €</b>
<b>KP 61</b>	060L110266	32	Mekanik Termostat -30°C / +13°C	<b>46,19 €</b>
<b>KP 61</b>	060L110366	32	Mekanik Termostat -30°C / +15°C	<b>57,97 €</b>
<b>KP 62</b>	060L110666	36	Mekanik Termostat -30°C / +15°C	<b>47,05 €</b>
<b>KP 73</b>	060L111866	32	Oda Termostatı -25°C / +15°C	<b>54,90 €</b>
<b>KP 73</b>	060L113866	32	Donma Termostatı -25°C / +15°C (Manuel Reset)	<b>46,52 €</b>



KP 73



KP 61



RT 140



KP 61



## Features

Laser-welded power element in stainless steel  
- longer diaphragm life  
- high pressure tolerance and working pressure  
- high corrosion resistance

Flare or solder outlet

Flare or solder pressure equalization

Interchangeable orifice assembly with dirt protection strainer

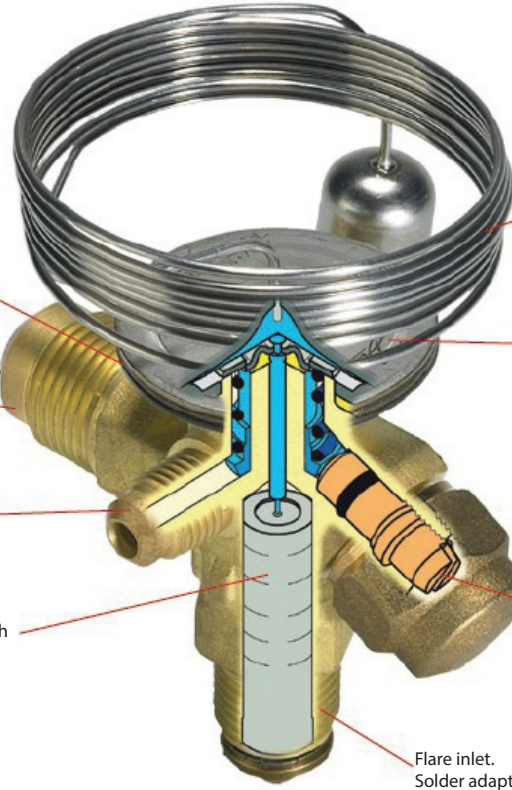

Stainless steel capillary tube and bulb:  
- high corrosion resistance  
- high strength and vibration resistance

Laser-engraved label

Easy adjustment of superheat setting

Flare inlet.  
Solder adaptor available as an option

Orfis No	Kod No	Paket Miktarı	R134a		R404A		R407C		R22		Fiyat
			Kw	TON	Kw	TON	Kw	TON	Kw	TON	
<b>T2 Orifis</b> 0X	068-2002	25	0,68	0,19	0,64	0,18	0,92	0,26	0,9	0,25	<b>10,46 €</b>
<b>T2 Orifis</b> 00	068-2003	25	1,20	0,34	1,30	0,37	1,80	0,51	1,8	0,51	
<b>T2 Orifis</b> 01	068-2010	25	2,10	0,59	2,60	0,75	3,5	1,00	3,5	0,99	
<b>T2 Orifis</b> 02	068-2015	25	2,50	0,73	3,70	1,10	4,8	1,40	4,7	1,30	
<b>T2 Orifis</b> 03	068-2006	25	4,30	1,20	6,30	1,80	8,1	2,30	8	2,30	
<b>T2 Orifis</b> 04	068-2007	25	6,40	1,80	9,90	2,80	12,4	3,50	12,10	3,50	
<b>T2 Orifis</b> 05	068-2008	25	8,40	2,30	13,00	3,70	16,5	4,70	16,70	4,80	
<b>T2 Orifis</b> 06	068-2009	25	10,10	2,90	15,50	4,40	19,7	5,60	19,70	5,60	

\* Kapasite değerleri +4,4°C evaporasyon ve +38°C kondansasyon şartlarındadır.



## T2 / TE2 DEĞİŞEBİLİR ORİFİSLİ EXPANSION VALFLER

Gaz Tipi	Bağlantı	Dış Denge	İç Denge	Range/Mop	Kod No	Paket Mik.	Fiyat	
R404A / R507	Kaynaklı		TS2	N Mopsuz	068Z3414	20	40,08 €	
		TES2		N Mopsuz	068Z3415	20	64,48 €	
		TES2		NL -10°C	068Z3430	20	64,48 €	
		TES2		B -20°C	068Z3421	20	64,48 €	
	Rekorlu			TS2	N Mopsuz	068Z3400	20	40,08 €
				TS2	NM 0°C	068Z3406	20	40,08 €
				TS2	B -20°C	068Z3410	20	40,08 €
		TES2			N Mopsuz	068Z3403	20	64,48 €
		TES2			NM 0°C	068Z3407	20	64,48 €
		TES2			NL -10°C	068Z3409	20	64,48 €
			TES2	B -20°C	068Z3411	20	64,48 €	
Gaz Tipi	Bağlantı	Dış Denge	İç Denge	Range/Mop	Kod No	Paket Mik.	Fiyat	
R134A	Kaynaklı	TEN2		N Mopsuz	068Z3385	20	64,48 €	
			TN2	N Mopsuz	068Z3383	20	40,08 €	
	Rekorlu		TN2	N Mopsuz	068Z3346	20	40,08 €	
		TEN2		N Mopsuz	068Z3348	20	64,48 €	
		TEN2		NM 0°C	068Z3392	20	64,48 €	
		TEN2		NL -10°C	068Z3370	20	64,48 €	
Gaz Tipi	Bağlantı	Dış Denge	İç Denge	Range/Mop	Kod No	Paket Mik.	Fiyat	
R22 / R407C	Kaynaklı		TX2	N Mopsuz	068Z3281	20	44,43 €	
		TEX2		N Mopsuz	068Z3284	20	71,45 €	
	Rekorlu		TX2	N Mopsuz	068Z3206	20	44,43 €	
		TEX2		N Mopsuz	068Z3209	20	71,45 €	
		TEX2		NM 0°C	068Z3225	20	85,74 €	
		TEX2		NL -10°C	068Z3227	20	71,45 €	
		TEX2		B -20°C	068Z3229	20	83,64 €	
Gaz Tipi	Bağlantı	Dış Denge	İç Denge	Range/Mop	Kod No	Paket Mik.	Fiyat	
R407C	Kaynaklı	TEZ2		N Mopsuz	068Z3446	20	64,48 €	
	Rekorlu				068Z3501	20		
Gaz Tipi	Bağlantı	Dış Denge	İç Denge	Range/Mop	Kod No	Paket Mik.	Fiyat	
R448A R449A	Kaynaklı		T2	N Mopsuz	068Z3729	20	68,57 €	
		TE2			068Z3730		71,25 €	

RANGE N -40°C & +10°C  
 RANGE NM -40°C & -5°C  
 RANGE NL -40°C & -15°C  
 RANGE B -60°C & -25°C

## Features

Laser-welded power element in stainless steel  
 - longer diaphragm life  
 - high pressure tolerance and working pressure  
 - high corrosion resistance

To ensure long operating life, the valve cone and seat are made of a special alloy with particularly good wear qualities.

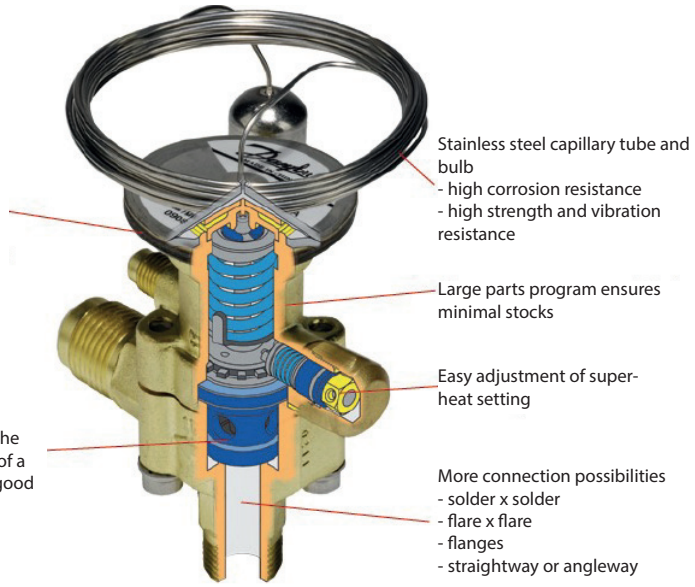

Stainless steel capillary tube and bulb  
 - high corrosion resistance  
 - high strength and vibration resistance

Large parts program ensures minimal stocks

Easy adjustment of super-heat setting

More connection possibilities  
 - solder x solder  
 - flare x flare  
 - flanges  
 - straightway or angleway

## TE5 - TE12 - TE20 - TE55 TERMOSTATİK EXPANSION VALFLER

### R404A / R507

Model	Range N Mopsuz	Pak. Mik.	Fiyat	Range NM Mop 0°C	Pak. Mik.	Fiyat	Range NL Mop -10°C	Pak. Mik.	Fiyat	Range B Mop -20°C	Pak. Mik.	Fiyat
TES 5	067B3342	12	108,74 €	067B3357	12	108,74 €	067B3358	12	108,74 €	067B3343	12	108,74 €
TES 12	067B3347	9	131,74 €	067B3345	9	131,74 €	067B3348	9	131,74 €	067B3349	9	146,38 €
TES 20	067B3352	9	250,93 €	067B3351	9	250,93 €	067B3353	9	250,93 €	067B3354	9	250,93 €
TES 55	067G3302	9	309,48 €	067G3303	9	309,48 €	067G3304	9	309,48 €	067G3305	9	309,48 €

### R22

Model	Range N Mopsuz	Pak. Mik.	Fiyat	Range NM Mop 0°C	Pak. Mik.	Fiyat	Range NL Mop -10°C	Pak. Mik.	Fiyat	Range B Mop -20°C	Pak. Mik.	Fiyat
TEX 5	067B3250	12	108,74 €	067B3249	12	108,74 €	067B3253	12	108,74 €	067B3251	12	108,74 €
TEX 12	067B3210	9	146,38 €	067B3207	9	146,38 €	067B3213	9	146,38 €	067B3211	9	146,38 €
TEX 20	067B3274	9	250,93 €	067B3273	9	250,93 €	067B3275	9	250,93 €	067B3276	9	250,93 €
TEX 55	067G3205	9	309,48 €	067G3206	9	309,48 €	-	-	-	067G3207	9	309,48 €

### R134a

Model	Range N Mopsuz	Pak. Mik.	Fiyat	Range NM Mop 0°C	Pak. Mik.	Fiyat
TEN 5	067B3297	12	108,74 €	067B3360	12	108,74 €
TEN 12	067B3232	9	131,74 €	-	-	-
TEN 20	067B3292	9	250,93 €	-	-	-
TEN 55	067G3222	9	309,48 €	-	-	-

RANGE N -40°C & +10°C  
 RANGE NM -40°C & -5°C  
 RANGE NL -40°C & -15°C  
 RANGE B -60°C & -25°C

### R448A/R449A

Model	Range N Mopsuz	Pak. Mik.	Fiyat	Range NL Mop -10°C	Pak. Mik.	Fiyat
TEN 5	067B3252	12	125,04 €	067B3376	12	106,61 €
TEN 12	067B2512	9	160,48 €	067B3377	9	157,35 €
TEN 20	067B3294	9	288,57 €	-	-	-
TEN 55	067G3219	9	309,49 €	-	-	-

### R407C

Model	Range N Mopsuz	Paket Mik.	Fiyat	Range NM Mop +15°C	Paket Mik.	Fiyat
TEZ 5	067B3278	12	108,74 €	067B3277	12	108,74 €
TEZ 12	067B3366	9	131,74 €	067B3367	9	131,74 €
TEZ 20	067B3371	9	250,93 €	067B3372	9	250,93 €
TEZ 55	067G3240	9	309,48 €	067G3241	9	309,48 €

## ORİFİS

Tip	Kod No	R134a		R404A		R407C		R22		R448A/R449A		Orfis No	Pak. Miktarı	Fiyat
		Kw	TR	Kw	TR	Kw	TR	Kw	TR	Kw	TR			
<b>TE5- 0,5</b>	067B2788	5	1,5	7	2	11	3	9	2,5	9	2,5	0,5	8	<b>41,83 €</b>
<b>TE5 - 1</b>	067B2789	11	3	14	4	18	5	16	4,5	18	5	1	8	<b>41,83 €</b>
<b>TE5 - 2</b>	067B2790	14	4,5	19	5,5	25	7	25	7	25	7	2	8	<b>41,83 €</b>
<b>TE5 - 3</b>	067B2791	18	6	25	7	32	9	32	9	32	9	3	8	<b>41,83 €</b>
<b>TE5 - 4</b>	067B2792	25	8	35	10	46	13	42	12	46	13	4	8	<b>41,83 €</b>
<b>TE12 - 5</b>	067B2708	35	10	49	14	53	15	56	16	53	15	5	8	<b>50,19 €</b>
<b>TE12 - 6</b>	067B2709	49	14	63	18	74	21	74	21	70	20	6	8	<b>50,19 €</b>
<b>TE12 - 7</b>	067B2710	63	18	81	23	94	26	95	27	91	26	7	8	<b>50,19 €</b>
<b>TE20 - 8</b>	067B2771	77	22	84	24	116	33	127	36	123	35	8	8	<b>89,93 €</b>
<b>TE20 - 9</b>	067B2773	91	26	102	29	136	38	148	42	141	40	9	8	<b>89,93 €</b>
<b>TE55 - 9B</b>	067G2705	74	21	84	24	109	31	113	32	113	32	9B	8	<b>120,25 €</b>
<b>TE55 - 10</b>	067G2701	109	31	127	36	162	46	169	48	155	44	10	8	<b>120,25 €</b>
<b>TE55 - 11</b>	067G2704	120	34	137	39	176	50	183	52	169	48	11	8	<b>120,25 €</b>
<b>TE55 - 12</b>	067G2707	134	38	151	43	190	54	200	57	186	53	12	8	<b>120,25 €</b>
<b>TE55 - 13</b>	067G2710	165	47	183	52	232	66	246	70	225	64	13	8	<b>120,25 €</b>

Evaporasyon Sıcaklığı +4,4°C, Kondanzasyon Sıcaklığı +38°C

## FLANŞ

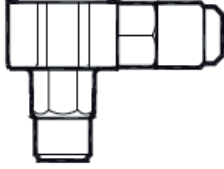
Tip	Bağlantı	Rekorlu	Fiyat	Kaynaklı 90°C	Pak. Miktarı	Fiyat	Kaynaklı Düz	Fiyat
<b>TE 5</b>	1/2" x 5/8"		<b>35,55 €</b>	067B4009	32	<b>35,55 €</b>	067B4007	<b>35,55 €</b>
	1/2" x 7/8"			067B4010	32	<b>35,55 €</b>	067B4008	<b>35,55 €</b>
	5/8" x 7/8"			067B4011	32	<b>35,55 €</b>	067B4032	<b>35,55 €</b>
	7/8" x 11/8"			067B4034	32	<b>35,55 €</b>	067B4033	<b>35,55 €</b>
<b>TE 12</b>	7/8" X 11/8"			067B4023	32	<b>38,69 €</b>	067B4021	<b>38,69 €</b>
<b>TE 20</b>	7/8" X 11/8"			067B4023	32	<b>38,69 €</b>	067B4021	<b>38,69 €</b>
<b>TE 55</b>	11/8" X 1 3/8"			067G4004	32	<b>49,15 €</b>	067G4003	<b>49,15 €</b>



### Termostatik Element

+  
Orfis  
+  
Flanş

## SABİT ORİFİSLİ EXPANSION VALFLER

Model	Kod No	Kapasite		Gaz	Bağlantı	Paket Miktarı	Fiyat
		Kw	TON				
<b>TGES 10-4</b>	067N6172	9	2,6	<b>Çalışma Aralığı +10°C -40°C</b>	1/2" x 7/8"	12	<b>106,65 €</b>
<b>TGES 10-6</b>	067N6151	14	4		1/2" x 7/8"	12	<b>115,01 €</b>
<b>TGES 10-8</b>	067N6166	18	5		1/2" x 7/8"	12	<b>125,47 €</b>
<b>TGES 10-11</b>	067N6154	26	7,5		5/8" x 7/8"	12	<b>135,93 €</b>
<b>TGES 20-12,5</b>	067N6158	31	9		5/8" x 7/8"	8	<b>177,74 €</b>
<b>TGES 20-16</b>	067N6181	39	11		7/8" x 1 1/8"	8	<b>214,33 €</b>
<b>TGES 20-20</b>	067N6162	45	13		7/8" x 1 1/8"	8	<b>230,03 €</b>
<b>TGES 40-26</b>	067N6161	64	18		7/8" x 1 3/8"	6	<b>292,76 €</b>

Model	Kod No	Kapasite		Gaz	Bağlantı	Paket Miktarı	Fiyat
		Kw	TON				
<b>TGEN 10-3</b>	067N5151	6	1,5	<b>Çalışma Aralığı +10°C -40°C</b>	1/2" x 5/8"	12	<b>135,93 €</b>
<b>TGEN 10-4</b>	067N5252	8	2,5		1/2" x 5/8"	12	<b>146,38 €</b>
<b>TGEN 10-6</b>	067N5153	12	3,5		1/2" x 5/8"	12	<b>156,83 €</b>
<b>TGEN 10-8</b>	067N5156	17	4,5		1/2" x 5/8"	12	<b>162,07 €</b>
<b>TGEN 10-11</b>	067N5157	24	7		5/8" x 7/8"	12	<b>167,29 €</b>
<b>TGEN 20-12,5</b>	067N5159	29	8		5/8" x 7/8"	8	<b>188,21 €</b>
<b>TGEN 20-16</b>	067N5161	37	10		5/8" x 1 1/8"	8	<b>209,11 €</b>
<b>TGEN 20-20</b>	067N5163	44	12		7/8" x 1 1/8"	8	<b>230,03 €</b>
<b>TGEN 40-26</b>	067N5165	61	17		7/8" x 1 3/8"	6	<b>292,76 €</b>
<b>TGEN 40-30</b>	067N5255	70	20		1 1/8" x 1 1/8"	6	<b>334,58 €</b>
<b>TGEN 40-40</b>	067N5169	87	25		1 1/8" x 1 3/8"	6	<b>355,48 €</b>



## SABİT ORİFİSLİ EXPANSION VALFLER

Model	Kod No	Kapasite		Gaz	Bağlantı	Paket Miktarı	Fiyat
		Kw	TON				
TGEZ 10-3	067N4151	9	2,5	Çalışma Aralığı +10°C -40°C  R407C	1/2" x 5/8"	12	100,37 €
TGEZ 10-4	067N4002 / 067N4152	13	3,5		1/2" x 7/8"	12	106,65 €
TGEZ 10-6	067N4154	19	5		1/2" x 7/8"	12	115,00 €
TGEZ 10-8	067N4156	25	7		5/8" x 7/8"	12	125,47 €
TGEZ 10-11	067N4157	36	10		5/8" x 7/8"	12	135,93 €
TGEZ 20-12,5	067N4159	42	12		5/8" x 7/8"	8	188,21 €
TGEZ 20-16	067N4162	53	15		7/8" x 1 1/8"	8	214,33 €
TGEZ 20-20	067N4163	62	18		7/8" x 1 1/8"	8	230,03 €
TGEZ 40-26	067N4165	84	24		7/8" x 1 3/8"	6	292,76 €
TGEZ 40-30	067N4167	95	27		7/8" x 1 3/8"	6	334,58 €
TGEZ 40-40	067N4169	121	34		1 1/8" x 1 3/8"	6	376,40 €

\* Kapasite değerleri +4,4°C Evaporasyon, +38°C Kondenzasyon şartlarına göre verilmiştir.

Model	Kod No	Kapasite		Gaz	Bağlantı	Paket Miktarı	Fiyat
		Kw	TON				
TGEL 10-3	067N9201	12	3,5	Çalışma Aralığı +15°C -30°C  R410A	1/2" x 5/8"	12	106,65 €
TGEL 10-4	067N9202	16	4,5		1/2" x 7/8"	12	115,01 €
TGEL 10-6	067N9200	24	6,5		5/8" x 7/8"	12	125,47 €
TGEL 10-8	067N9206	32	9		5/8" x 7/8"	12	125,47 €
TGEL 10-11	067N9207	45	13		5/8" x 7/8"	12	135,93 €
TGEL 20-12,5	067N9209	54	15		5/8" x 7/8"	8	188,21 €
TGEL 20-16	067N9212	68	19		7/8" x 1 1/8"	8	214,33 €
TGEL 20-20	067N9213	79	23		7/8" x 1 1/8"	8	230,03 €
TGEL 40-26	067N9285	110	31		7/8" x 1 1/8"	6	292,76 €
TGEL 40-30	067N9218	125	35		1 1/8" x 1 3/8"	6	334,58 €
TGEL 40-40	067N9219	161	46		1 1/8" x 1 3/8"	6	376,40 €

\* Kapasite değerleri +4,4°C Evaporasyon, +38°C Kondenzasyon şartlarına göre verilmiştir.



## TUAE ÇİFT YÖNLÜ EXPANSION VALF R410A

Model	Kod No	Çalışma Aralığı	Gaz	Bağlantı	Paket Miktarı	Fiyat
<b>TUAE</b>	068U1714	+10°C / -40°C	R410A	3/8" x 1/2"	24	<b>67,10 €</b>

Orifis	Kod No	Kw	Ton	Fiyat (€)
<b>No: 00</b>	068U1030	0,99	0,28	<b>17,42 €</b>
<b>No: 01</b>	068U1031	1,3	0,38	
<b>No: 02</b>	068U1032	1,7	0,48	
<b>No: 03</b>	068U1033	2,1	0,6	
<b>No: 04</b>	068U1034	4,1	1,2	
<b>No: 05</b>	068U1035	5,3	1,5	
<b>No: 06</b>	068U1036	8,5	2,4	
<b>No: 07</b>	068U1037	11,2	3,2	
<b>No: 08</b>	068U1038	15,8	4,5	
<b>No: 09</b>	068U1039	23,1	6,6	



## YAĞ AYIRICI

Model	Kod No	Bağlantı	Paket Miktarı	Fiyat
<b>OUB 1</b>	040B0010 + 2 X 040B0140	3/8"	4	<b>200,74 €</b>
	040B0010 + 2 X 040B0142	1/2"	4	<b>202,52 €</b>
	040B0010 + 2 X 040B0144	5/8"	4	<b>206,10 €</b>
<b>OUB 4</b>	040B0040 + 2 X 040B0266	5/8"	1	<b>373,05 €</b>
	040B0040 + 2 X 040B0258	3/4"	1	<b>381,95 €</b>
	040B0040 + 2 X 040B0264	7/8"	1	<b>378,39 €</b>
	040B0040 + 2 X 040B0265	1 1/8"	1	<b>390,81 €</b>





## HEAT EXCHANGER

Model	Kod No	Bağlantı			Paket Miktarı	Fiyat
		Sıvı Hattı	Emiş Hattı			
<b>HE 0.5</b>	015D0002	1/4"	1/2"		18	<b>142,12 €</b>
<b>HE 1.0</b>	015D0004	3/8"	5/8"		18	<b>159,87 €</b>
<b>HE 1.5</b>	015D0006	1/2"	3/4"		12	<b>174,10 €</b>
<b>HE 4.0</b>	015D0008	1/2"	1 1/8"		10	<b>219,39 €</b>
<b>HE 8.0</b>	015D0010	5/8"	1 5/8"		10	<b>349,95 €</b>

## EMİŞ FİLTRESİ

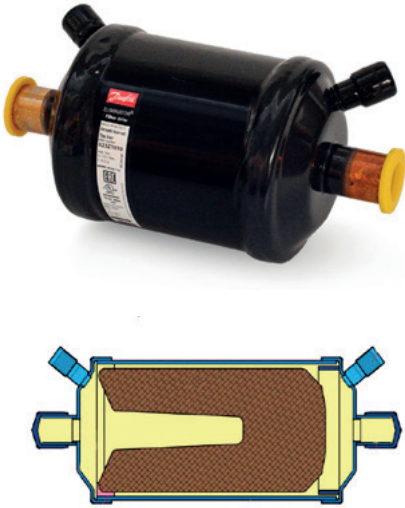
Model	Kod No	Bağlantı		Paket Miktarı	Fiyat
<b>DAS 164</b>	023Z1009	1/2"			12
<b>DAS 165</b>	023Z1010	5/8"		12	<b>27,33 €</b>
<b>DAS 166</b>	023Z1011	3/4"		12	<b>27,33 €</b>
<b>DAS 167</b>	023Z1012	7/8"		12	<b>27,33 €</b>
<b>DAS 305</b>	023Z1013	5/8"		8	<b>38,44 €</b>
<b>DAS 306</b>	023Z1014	3/4"		8	<b>38,44 €</b>
<b>DAS 307</b>	023Z1015	7/8"		8	<b>38,44 €</b>
<b>DAS 309</b>	023Z1016	1 1/8"		8	<b>38,44 €</b>
<b>DAS 417</b>	023Z1017	7/8"		8	<b>45,27 €</b>
<b>DAS 419</b>	023Z1018	1 1/8"		8	<b>45,27 €</b>



## RAKORLU TAŞ DRIERLER

Model	Kod No	Bağlantı		Paket Miktarı	Fiyat
DML 032	023Z5035	1/4"		32	6,83 €
DML 033	023Z5036	3/8"		32	6,83 €
DML 052	023Z5037	1/4"		24	8,55 €
DML 053	023Z5038	3/8"		24	8,55 €
DML 083	023Z5040	3/8"		24	10,25 €
DML 084	023Z5041	1/2"		24	10,25 €
DML 163	023Z5043	3/8"		12	12,81 €
DML 164	023Z5044	1/2"		12	12,81 €
DML 165	023Z5045	5/8"		12	12,81 €
DML 166	023Z5046	3/4"		12	12,81 €
DML 303	023Z0049	3/8"		8	22,22 €
DML 304	023Z0050	1/2"		8	22,22 €
DML 305	023Z0051	5/8"		8	22,22 €
DML 306	023Z0193	3/4"		8	22,22 €
DML 415	023Z0110	5/8"		8	44,42 €

## KARTUŞ DRIER

Model	Kod No	Ürün Adı		Paket Miktarı	Fiyat
48-DC	023U4381	Kartuş Drier		8	17,09 €
48-DA	023U5381	Kartuş Drier yanık için		8	41,00 €
48-F	023U1921	Kartuş Filtre		8	34,17 €

## KARTUŞ KOVANLARI

Model	Kod No	Bağlantı	Kartuş Drayer		Paket Miktarı	Fiyat
DCR 0485S	023U7250	5/8"	1		1	122,16 €
DCR 0487S	023U7251	7/8"			1	122,16 €
DCR 0489S	023U7253	1 1/8"			1	129,84 €
DCR 04811S	023U7254	1 3/8"			1	129,84 €
DCR 09611S	023U7261	1 3/8"	2		1	130,69 €
DCR 09613S	023U7263	1 5/8"			1	130,69 €
DCR 14413S	023U7269	1 5/8"	3		1	167,43 €
DCR 14417S	023U7270	2 1/8"			1	191,35 €

## KAYNAKLI TAŞ DRIERLER

Model	Kod No	Bağlantı		Paket Miktarı	Fiyat
DML 032S	023Z4552	1/4"		32	6,83 €
DML 033S	023Z4555	3/8"		32	6,83 €
DML 052S	023Z4559	1/4"		24	8,55 €
DML 053S	023Z4562	3/8"		24	8,55 €
DML 083S	023Z4570	3/8"		24	10,25 €
DML 084S	023Z4572	1/2"		24	10,25 €
DML 163S	023Z4578	3/8"		12	12,81 €
DML 164S	023Z4580	1/2"		12	12,81 €
DML 165S	023Z4581	5/8"		12	12,81 €
DML 304S	023Z4587	1/2"			8
DML 305S	023Z4588	5/8"	8		22,22 €
DML 306S	023Z4589	3/4"	8		22,22 €
DML 307S	023Z4590	7/8"	8		22,22 €
DML 415S	023Z4595	5/8"	8		39,30 €
DML 417S	023Z4596	7/8"	8		39,30 €
DML 757S	023Z4605	7/8"	12		61,50 €
DML 759S	023Z4607	1 1/8"	12		73,47 €

## ÇİFT YÖNLÜ DRIERLER

Model	Kod No	Bağlantı		Paket Miktarı	Fiyat
DMB 082S	023Z1443	1/4"		24	18,26 €
DMB 083S	023Z1442	3/8"		24	18,26 €
DMB 084S	023Z1441	1/2"		24	18,26 €
DMB 163S	023Z1476	3/8"		12	18,80 €
DMB 164S	023Z1475	1/2"		12	18,80 €
DMB 165S	023Z1474	5/8"		12	18,80 €
DMB 305S	023Z1478	5/8"		8	32,46 €
DMB 307S	023Z1477	7/8"		8	32,46 €
DMB 309S	023Z1493	1 1/8"		8	44,42 €



## RAKORLU SOLENOID VALFLER

Model	Kod No	EVRest Yeni Kod	Bağlantı		Paket Miktarı	Fiyat
<b>EVR 3</b>	032F8107	032F8107	1/4"		24	<b>29,90 €</b>
<b>EVR 3</b>	032F8116	032F8116	3/8"		24	<b>29,90 €</b>
<b>EVR 6</b>	032F8079	032L8079	1/2"		12	<b>43,56 €</b>
<b>EVR 10</b>	032F8098	032L8098	5/8"		12	<b>59,80 €</b>

\* Fiyatlara bobin dahil değildir.



\* Çalışma aralığı -40°C / +105°C

## BOBİNLER

Model	Voltaj	Kod No	Paket Miktarı	Fiyat
<b>BE230CS BOBİN 17W IP20</b>	220/230V 50 / 60Hz	018F6193	50	<b>17,42 €</b>
<b>BE230CS BOBİN 17W IP67</b>		018F6732	32	<b>29,63 €</b>
<b>BE230AS BOBİN 12W IP67</b>	220/230V 50Hz	018F6251	24	<b>26,14 €</b>
<b>BE230AS BOBİN 12W IP20</b>	220/230V 50Hz	018F6176	50	<b>17,42 €</b>
<b>BE230AS BOBİN 12W IP67 (Terminal Kutu)</b>	220V 50Hz	018F6701	32	<b>26,14 €</b>
<b>BE110CS BOBİN 15W IP67 (Terminal Kutu)</b>	110V 50-60Hz	018F6730	32	<b>26,14 €</b>
<b>BE440CS BOBİN 13W IP67</b>	380V 50Hz	018F6703	32	<b>26,14 €</b>
<b>BG012DS BOBİN 20W IP67 (Terminal Kutu)</b>	12V DC	018F6856	24	<b>29,63 €</b>
<b>BG024DS BOBİN 16W IP67 (Terminal Kutu)</b>	24V DC	018F6857	24	<b>29,63 €</b>
<b>BE024AS BOBİN 12W IP67</b>	24V AC	018F6707	32	<b>26,14 €</b>

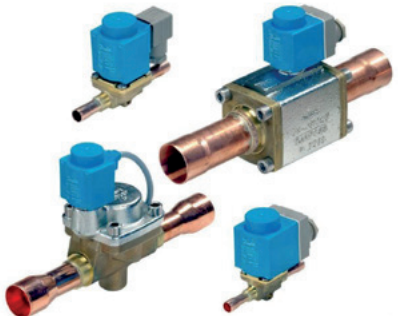

## KAYNAKLI SOLENOID VALFLER





Model	Kod No	EVRest Yeni Kod	Bağlantı		Paket Miktarı	Fiyat
<b>EVR 2</b>	032F1201	032F1201	1/4"		24	<b>27,33 €</b>
<b>EVR 3</b>	032F1206	032F1206	1/4"		24	<b>29,90 €</b>
<b>EVR 3</b>	032F1204	032F1204	3/8"		24	<b>29,90 €</b>
<b>EVR 6</b>	032F1212	032L1212	3/8"		12	<b>43,56 €</b>
<b>EVR 6</b>	032F1209	032L1209	1/2"		12	<b>43,56 €</b>
<b>EVR 10</b>	032F1217	032L1217	1/2"		12	<b>59,80 €</b>
<b>EVR 10</b>	032F1214	032L1214	5/8"		12	<b>59,80 €</b>
<b>EVR 15</b>	032F1228	032L1228	5/8"		9	<b>99,09 €</b>
<b>EVR 15</b>	032F1225	032L1225	7/8"		9	<b>99,09 €</b>
<b>EVR 20</b>	032F1240	032L1240	7/8"		6	<b>142,66 €</b>
<b>EVR 20</b>	032F1244	032L1244	1 1/8"	6	<b>148,64 €</b>	
<b>EVR 22</b>	032F3267	032L3267	1 3/8"		6	<b>203,30 €</b>
<b>EVR 25</b>	032F2201	032L2201	1 1/8"		6	<b>252,84 €</b>
<b>EVR 25</b>	032F2208	032L2208	1 3/8"		6	<b>252,84 €</b>
<b>EVR 32</b>	042H1106	032L1106	1 3/8"		1	<b>371,58 €</b>
<b>EVR 32</b>	042H1104	032L1104	1 5/8"		1	<b>371,58 €</b>
<b>EVR 40</b>	042H1110	032L1110	1 5/8"		1	<b>437,36 €</b>
<b>EVR 40</b>	042H1112	032L1112	2 1/8"		1	<b>437,36 €</b>

\* Fiyatlara bobin dahil değildir.

\* Çalışma aralığı -40°C / +105°C



## BASINÇ REGÜLATÖRLERİ

Model	Kod No	Bağlantı	Evaporatör Basınç Regülatörü	Paket Miktarı	Fiyat
<b>KVP 12</b>	034L0023	1/2"		12	<b>112,40 €</b>
<b>KVP 15</b>	034L0029	5/8"		12	<b>112,40 €</b>
<b>KVP 22</b>	034L0025	7/8"		12	<b>174,25 €</b>
<b>KVP 28</b>	034L0026	1 1/8"		7	<b>260,51 €</b>
<b>KVP 35</b>	034L0032	1 3/8"		7	<b>278,82 €</b>
Model	Kod No	Bağlantı	Karter Basınç Regülatörü	Paket Miktarı	Fiyat
<b>KVL 12</b>	034L0043	1/2"		12	<b>93,23 €</b>
<b>KVL 15</b>	034L0049	5/8"		12	<b>93,23 €</b>
<b>KVL 22</b>	034L0045	7/8"		12	<b>145,51 €</b>
<b>KVL 28</b>	034L0046	1 1/8"		7	<b>216,07 €</b>
<b>KVL 35</b>	034L0052	1 3/8"		7	<b>223,93 €</b>
Model	Kod No	Bağlantı	Kondanser Basınç Regülatörü	Paket Miktarı	Fiyat
<b>KVR 12</b>	034L0093	1/2"		12	<b>139,40 €</b>
<b>KVR 15</b>	034L0097	5/8"		12	<b>156,83 €</b>
<b>KVR 22</b>	034L0094	7/8"		12	<b>174,25 €</b>
<b>KVR 28</b>	034L0095	1 1/8"		7	<b>278,82 €</b>
<b>KVR 35</b>	034L0100	1 3/8"		7	<b>272,72 €</b>
Model	Kod No	Bağlantı	Kapasite Regülatörü	Paket Miktarı	Fiyat
<b>KVC 12</b>	034L0143	1/2"		12	<b>105,43 €</b>
<b>KVC 15</b>	034L0147	5/8"		12	<b>108,91 €</b>
<b>KVC 22</b>	034L0144	7/8"		12	<b>180,36 €</b>
Model	Kod No	Bağlantı	Sıcak Gaz Bypass Regülatörü	Paket Miktarı	Fiyat
<b>CPCE 12</b>	034N0082	1/2"		8	<b>246,58 €</b>
<b>CPCE 15</b>	034N0083	5/8"		8	<b>257,04 €</b>
<b>CPCE 22</b>	034N0084	7/8"		8	<b>413,87 €</b>
Model	Kod No	Bağlantı	Check Valf	Paket Miktarı	Fiyat
<b>NRD12s</b>	020B1132	1/2"		24	<b>81,55 €</b>

\* KVR Basınç regülatörleri ile NRD check valf kullanılması gerekmektedir.



## KAYNAKLI GÖZETLEME CAMLARI

Model	Kod No	Bağlantı				Paket Miktarı	Fiyat
<b>SGN 6S</b>	014-0181	1/4"	 <p><b>35 Bar / 500 psi / -50°C / +80°C</b></p>			25	<b>10,25 €</b>
<b>SGN 10S</b>	014-0182	3/8"				25	<b>11,11 €</b>
<b>SGN 12S</b>	014-0183	1/2"				28	<b>12,81 €</b>
<b>SGN 16S</b>	014-0184	5/8"				28	<b>17,09 €</b>
<b>SGN 19S</b>	014-0185	3/4"				28	<b>23,92 €</b>
<b>SGN 22S</b>	014-0186	7/8"				28	<b>29,90 €</b>
<b>SGN 22S</b>	014-0187	1 1/8"				28	<b>29,90 €</b>
						KURU	NEMLİ

Model	Kod No	Bağlantı				Paket Miktarı	Fiyat
<b>SGP 6s N</b>	014L0181	1/4"	 <p><b>52 Bar / 754 psi / -50°C / +80°C</b></p>			25	<b>13,67 €</b>
<b>SGP 10s N</b>	014L0182	3/8"				25	<b>15,08 €</b>
<b>SGP 12s N</b>	014L0183	1/2"				28	<b>18,80 €</b>
<b>SGP 16s N</b>	014L0184	5/8"				28	<b>25,63 €</b>
<b>SGP 19s N</b>	014L0185	3/4"				28	<b>30,76 €</b>
<b>SGP 22s N</b>	014L0186	7/8"				28	<b>35,88 €</b>
<b>SGP 22s N</b>	014L0187	1 1/8"				28	<b>35,88 €</b>
						KURU	NEMLİ

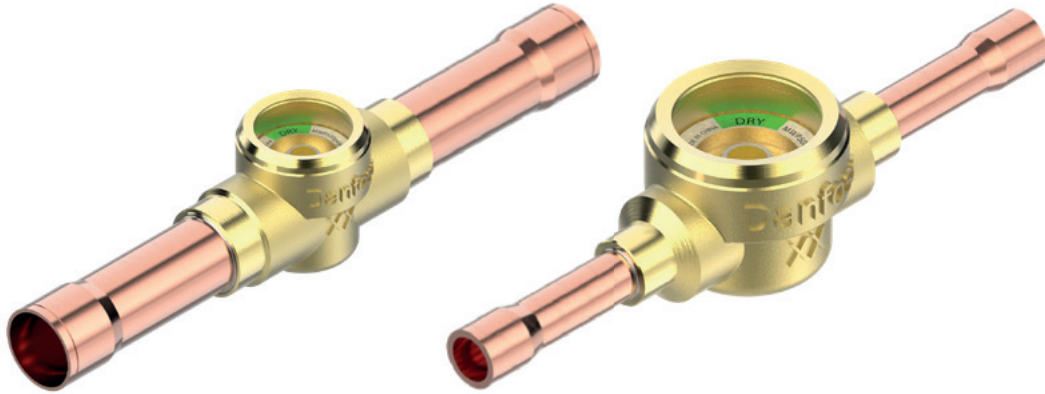

## KÜRESEL VANALAR

Model	Kod No	Yeni Kod No	Bağlantı		Paket Miktarı	Fiyat
<b>GBC 6S</b>	009G7050	009L7050	1/4"		25	<b>20,51 €</b>
<b>GBC 10S</b>	009G7051	009L7051	3/8"		25	<b>22,56 €</b>
<b>GBC 12S</b>	009G7052	009L7052	1/2"		25	<b>24,60 €</b>
<b>GBC 16S</b>	009G7053	009L7053	5/8"		25	<b>26,65 €</b>
<b>GBC 18S</b>	009G7054	009L7054	3/4"		25	<b>36,90 €</b>
<b>GBC 22S</b>	009G7055	009L7055	7/8"		25	<b>41,00 €</b>
<b>GBC 28S</b>	009G7056	009L7056	1 1/8"		5	<b>61,50 €</b>
<b>GBC 35S</b>	009G7057	009L7057	1 3/8"		5	<b>123,01 €</b>
<b>GBC 42S</b>	009G7058	009L7058	1 5/8"		4	<b>184,50 €</b>
<b>GBC 54S</b>	009G7059	009L7059	2 1/8"		2	<b>328,02 €</b>
<b>GBC 67S</b>	009G7960	009L7960	2 5/8"		1	<b>742,14 €</b>
<b>GBC 79S</b>	009G7981	009L7981	3 1/8"		1	<b>1.010,69 €</b>

1/4" Subaplı Servis Portu

## SU REGÜLATÖR VALFLERİ

Model	Kod No	Bağlantı			Paket Miktarı	Fiyat
		Su Girişi	Bar	Kondanser Bağlantı Ölçüsü		
<b>WVFX 10</b>	003N1105	3/8"	4,0 - 23		10	<b>89,75 €</b>
<b>WVFX 15</b>	003N2105	1/2"			10	<b>96,72 €</b>
<b>WVFX 20</b>	003N3100	3/4"			10	<b>136,80 €</b>
<b>WVFX 25</b>	003N4105	1"			10	<b>155,09 €</b>
<b>WVFX 32</b>	003F1232	1 1/4"	4,0 - 17		4	<b>263,13 €</b>
<b>WVFX 40</b>	003F1240	1 1/2"			4	<b>277,95 €</b>

1/4" in. / 6mm flare

## CHECK VALFLER

Model	Kod No	Bağlantı		Paket Miktarı	Fiyat
<b>NRV 6</b>	020-1040	1/4"		25	<b>12,55 €</b>
<b>NRV 10</b>	020-1041	3/8"		25	<b>14,64 €</b>
<b>NRV 12</b>	020-1042	1/2"		25	<b>15,69 €</b>
<b>NRV 16</b>	020-1043	5/8"		25	<b>18,82 €</b>
<b>NRV 19</b>	020-1044	3/4"		24	<b>28,22 €</b>

Model	Kod No	Bağlantı		Paket Miktarı	Fiyat
<b>NRV 6S</b>	020-1010	1/4"		25	<b>12,55 €</b>
<b>NRV 10S</b>	020-1011	3/8"		25	<b>14,64 €</b>
<b>NRV 12S</b>	020-1012	1/2"		24	<b>15,69 €</b>
<b>NRV 16S</b>	020-1018	5/8"		24	<b>18,82 €</b>
<b>NRV 19S</b>	020-1019	3/4"		28	<b>28,22 €</b>
<b>NRV 19S</b>	020-1054	7/8"	28	<b>28,22 €</b>	

Model	Kod No	Bağlantı		Paket Miktarı	Fiyat
<b>NRV 22S</b>	020-1020	7/8"		18	<b>36,59 €</b>
<b>NRV 22S</b>	020-1060	1 1/8"		18	<b>51,24 €</b>
<b>NRV 28S</b>	020-1021	1 1/8"		6	<b>77,37 €</b>
<b>NRV 35S</b>	020-1026	1 3/8"		6	<b>92,01 €</b>
<b>NRV 35S</b>	020-1061	1 5/8"	6	<b>92,01 €</b>	

\* Çalışma basıncı 46 bardır.

## 4 YOLLU SOLENOID VALFLER

Model	Kod No	Kapasite		Bağlantı	Paket Miktarı	Fiyat
		R407C	R410A			
STF-0201G3	061L1144	10.11 kw	12,43 kw	3/8" - 1/2"	32	<b>31,81 €</b>
STF-0301G3	061L1194	12.29 kW	15.08 kW	1/2" - 5/8"	32	<b>37,67 €</b>
STF-0306G3	061L1151	12.29 kW	15.08 kW	1/2" - 3/4"	32	<b>37,85 €</b>
STF-0401G3	061L1152	22.40 kW	27.51 kW	1/2" - 3/4"	24	<b>67,69 €</b>
STF-0712G3	061L1195	38.05 kW	46.74 kW	3/4" - 7/8"	6	<b>107,82 €</b>
STF-1511G3	061L1224	42.39 kW	52.05 kW	7/8" - 1 1/8"	1	<b>206,28 €</b>
STF-2011G3	061L1219	54.18 kW	66.55 kW	7/8" - 1 1/8"	1	<b>211,06 €</b>
STF-2505G3	061L1279	81.89 kW	100.56 kW	1 1/8" - 1 3/8"	1	<b>366,71 €</b>
STF-3003G3	061L1282	115.61 kW	141.98 kW	1 1/8" - 1 5/8"	1	<b>508,00 €</b>
STF-4001G3	061L1284	161.37 kW	198.18 kW	1 1/2" - 1 3/4"	1	<b>641,62 €</b>
STF-5002G3	061L1287	209.54 kW	246.98 kW	1 5/8" - 2 1/8"	1	<b>1.141,56 €</b>
VHV-6001	061L1186	333.56 kW	413.77 kW	1 5/8" - 2 5/8"	1	<b>3.749,93 €</b>
STF-01AJ512D1	061L2074	Bobin 220-240V 6Watt 2 mt kablo IP54			60	<b>11,21 €</b>
STF-01AB503B1	061L2038	Bobin 24V 6 Watt 2 mt kablo IP100			100	<b>14,23 €</b>

\* 4 Yollu valf fiyatlarına bobin dahil değildir.

## FAZ HIZ KONTROL MODÜLLERİ

Model	Kod No	Çalışma Aralığı	Fabrika Set Değeri	Nominal Amper	Voltaaj	Paket Miktarı	Fiyat
XGE-4CI	061H3141	10-25 bar	19 bar	0,2~3 Amp.	220 V	60	<b>75,70 €</b>
RGE-Z1N4-7DS	061H3005	8-28 bar	19 bar	0,2~4 Amp.	220 V	20	<b>180,52 €</b>
RGE-Z1P4-7DS	061H3008	8-28 bar	19 bar	0,2~6 Amp.	220 V	16	<b>233,73 €</b>
RGE-Z1Q4-7DS	061H3009	8-28 bar	19 bar	0,2~8 Amp.	220 V	16	<b>277,54 €</b>
RGE-X3R4-7DS	061H3006	8-28 bar	16 bar	0,2~5 Amp.	380 V	6	<b>693,07 €</b>
RGE-Z1N6-7DS	061H3021	16-39 bar	32 bar	0,2~4 Amp.	220 V	20	<b>182,09 €</b>
RGE-Z1P6-7DS	061H3022	16-39 bar	32 bar	0,2~6 Amp.	220 V	16	<b>244,32 €</b>
RGE-Z1Q6-7DS	061H3023	16-39 bar	32 bar	0,2~8 Amp.	220 V	16	<b>284,23 €</b>
RGE-X3R6-7DS	061H3028	16-39 bar	32 bar	0,2~5 Amp.	380 V	6	<b>722,10 €</b>

\* Bağlantı 1/4" dişi rakorludur.



## WENTO AKSİYAL FANLAR - EMME

Model	Devir (d/dk)	Amper (A)	Güç (Watt)	Hava Debisi (m <sup>3</sup> /h)	Voltaj 50 Hz	Fiyat
RFC4-020-XLB	1.460	0,12	29	490	230	<b>29,50 \$</b>
RFC4-025-XLB	1.380	0,22	50	1.000	230	<b>31,50 \$</b>
RFC4-030-XLB	1.370	0,38	90	1.900	230	<b>33,90 \$</b>
RFC4-035-XLB	1.370	0,68	138	2.980	230	<b>45,20 \$</b>
RFC6-035-XLB	930	0,4	80	2.100	230	<b>48,25 \$</b>
RFC4-040-XLB	1.350	0,81	180	3.700	230	<b>49,95 \$</b>
RFC6-040-XLB	940	0,67	115	2.800	230	<b>53,20 \$</b>
RFCT4-040-XLB	1.380	0,48	190	3.900	380	<b>53,20 \$</b>
RFC4-045-XLB	1.380	1,15	250	5.100	230	<b>56,30 \$</b>
RFC6-045-XLB	950	0,6	120	3.100	230	<b>60,20 \$</b>
RFCT4-045-XLB	1.380	0,58	250	5.100	380	<b>60,20 \$</b>
RFC4-050-XLB	1.320	1,85	420	6.950	230	<b>74,50 \$</b>
RFC6-050-XLB	920	1,15	230	5.200	230	<b>79,35 \$</b>
RFGT4-050-XLB	1.320	0,93	450	7.000	380	<b>79,35 \$</b>
RFGC6-063-XLB	930	2,2	500	9.600	230	<b>130,90 \$</b>
RFGT6-063-XLB	920	1,57	550	9.580	380	<b>130,90 \$</b>
RFCT4-063-XLB	1.365	1,95	860	13.000	380	<b>138,75 \$</b>
* RFGT4-063XQ	1.350	3,5	1.900	15.300	400 Volt Δ/Y	<b>474,20 \$</b>
	1.050	2,3	1.400	11.900		
* RFGT6-071XQ	900	2,35	1.100	15.800		<b>498,40 \$</b>
	1.050	1,2	700	13.500		
* RFGT6-080XQ	880	3,65	1.650	20.800		<b>506,92 \$</b>
	700	1,94	1.060	15.600		
* RFGT6-091XQ	870	4,7	2.450	25.500		<b>699,70 \$</b>
	670	2,6	1.550	21.000		

\* Davlumbazlı model.



**WENTO EXTERNAL ROTOR MOTORLU PLUG FANLAR**

Model	Kanat Çapı Ø (mm)	Watt (W)	Devir (d/dk)	Hava Debisi (m³/h)	Voltaj	Fiyat
2E175-GH	175	60	2.610	505	220V	36,50 \$
2E192-GH	192	70	2.450	540		35,77 \$
2E225-GH	225	150	2.600	1.040		47,50 \$
2E250-GH	250	200	2.600	1.450		54,85 \$
2E280-GH	280	250	2.500	1.750		79,75 \$
4E310-GH	310	140	1.370	1.650		95,90 \$
4E355-GH-2	355	220	1.360	2.451		109,75 \$
4E400-GH	400	560	1.350	4.100		177,75 \$
4E450-GH	450	830	1.340	5.600		226,65 \$
4E500-GH	500	1550	1.380	7.600		374,50 \$
4D400-GH	400	560	1.350	4.050	380V	172,75 \$
4D500-GH	500	1560	1.330	7.400		334,50 \$

\* Emiş Ağız Sıvaması Fiyatlara **DAHİLDİR.**



## WENTO AKSİYAL FANLAR - ÜFLEME

Model	Devir (d/dk)	Akım (A)	Güç (Watt)	Hava Debisi (m³/h)	Voltaj 50 Hz	Fiyat
RFC4-020-YLB	1.460 d/dk	0,12	29	490	230	<b>31,60 \$</b>
RFC4-025-YLB	1.380 d/dk	0,22	50	1.000	230	<b>33,60 \$</b>
RFC4-030-YLB	1.370 d/dk	0,38	90	1.900	230	<b>36,10 \$</b>
RFC4-035-YLB	1.370 d/dk	0,68	138	2.980	230	<b>48,20 \$</b>
RFC4-040-YLB	1.350 d/dk	0,81	180	3.700	230	<b>53,20 \$</b>
RFC4-045-YLB	1.380 d/dk	1,15	250	4.800	230	<b>60,20 \$</b>
RFC4-050-YLB	1.320 d/dk	1,85	420	6.950	230	<b>79,35 \$</b>

## WENTO AKSİYAL FANLAR - EMME (PASLANMAZ)

Model	Devir (d/dk)	Akım (A)	Güç (Watt)	Hava Debisi (m³/h)	Voltaj 50 Hz	Fiyat
RFC4-045-XLB	1.380	1,15	250	4.800	230	<b>228,90 \$</b>
RFC4-050-XLB	1.320	1,85	420	6.950	230	<b>307,65 \$</b>

## WENTO AKSİYAL FANLAR - 7 KANAT

Model	Devir (d/dk)	Akım (A)	Güç (Watt)	Hava Debisi (m³/h)	Voltaj 50 Hz	Fiyat
RFC4-050-XLB-7b	1.400	1,85	420	7.000	230	<b>102,75 \$</b>
RFC4-050-YLB-7b						<b>102,75 \$</b>



## CUOGHI NEM ALICI

Model	Özellikler	Fiyat
<b>F7115W</b>	<b>NADER MIDI 3DL EG2 RAL 9006 (PURE WHITE)</b> 4 Lt. Sıvı Tankı - Elektronik Şamandıra - Elektronik Nem Ölçer - Hava Filtresi - Otomatik Defrost Sistemi - Hacim: 250m3 - Çalışma Şartları: +5°C...+32°C, 35... 100%R.H. - Kapasite: 30°C, 80%R.H. şartında <b>18,6 L/24 saat</b> - 230 V, 50 Hz	<b>952,30 €</b>
<b>F7101</b>	<b>NADER MIDI 4 EG</b> 6 Lt. Sıvı Tankı - Elektronik Şamandıra - Elektronik Nem Ölçer - Hava Filtresi - Otomatik Defrost Sistemi - Hacim: 400 m3 - Çalışma Şartları: +5°C...+32°C, 35... 100%R.H. - Kapasite: 30°C, 80%R.H. şartında <b>28 L/24 saat</b> - 230 V, 50 Hz	<b>1.155,60 €</b>
<b>F8060</b>	<b>WMD-30 EG WALL DEHUMIDIFER</b> 4 Lt. Sıvı Tankı - Elektronik Şamandıra - Elektronik Nem Ölçer - Hava Filtresi - Sıcak Gaz Defrost - Hacim: 150 m3 - Çalışma Şartları: +10°C...+35°C, 35... 100%R.H. - Kapasite: 30°C, 80%R.H. şartında <b>21,6 L/24 saat</b> - 230 V, 50 Hz	<b>1.177,00 €</b>
<b>F7114</b>	<b>NADER EG2</b> 12 Lt. Sıvı Tankı - Elektronik Şamandıra - Elektronik Nem Ölçer - Hava Filtresi - Sıcak Gaz Defrost Sistemi - Hacim: 600 m3 - Çalışma Şartları: +2°C...+32°C, 35... 100%R.H. - Kapasite: 30°C, 80%R.H. şartında <b>54 L/24 saat</b> - 230 V, 50 Hz	<b>1.926,00 €</b>
<b>F7112</b>	<b>NADER YARD PRO EG</b> Endüstriyel Yapılar - Elektronik Kontrol Paneli - Timer - Elektronik Nem Ölçer - Hava Filtresi - Sıcak Gaz Defrost Sistemi - Hacim: 800 m3 - Çalışma Şartları: +2°C...+32°C, 35... 100%R.H. - Kapasite: 30°C, 80%R.H. şartında <b>81 L/24 saat</b> - 230 V, 50 Hz	<b>3.204,65 €</b>

NADER midi serisi, müzeler, depolar, odalar ve aşırı nemin çözümünün büyük problem olduğu tüm durumlar ile kıymetli malzeme veya binaların aşırı nemden güvenle korunması için tasarlanmıştır. Defrost çevrimini verimli şekilde kontrol eden bir elektronik kontrol paneli ve sadece gerekli olduğunda üniteyi açan bir nem ölçer ile donatılmıştır; dahası özel dizaynı duvar karşısına veya iki mobilya arasına, az kullanılan boşluklara kurulmasına olanak verir. Tüm üniteler opsiyonel kesintisiz su boşaltım için ayarlanır. NADER ayrıca +20C'ye kadar verimli nem almaya izin veren sıcak gaz defrost cihazıyla da donatılmıştır.



## CUOGHI ADYABATİK NEMLENDİRİCİ

Model	Voltaj	Nemlendirme Kapasitesi (lt/h)	Çalışma Sıcaklığı	Güç Tüketimi (Watt)	Hava Debisi (m³/h)	Fiyat
<b>MINI NEB F2075</b>	220V / 50 Hz	1	+1°C - +35°C	23	80	<b>470,80 €</b>
<b>NEB 6500 F2060.2</b>		6,5		220	280	<b>1.064,65 €</b>



NEB 6500



Mini NEB



UCV Serisi



AC Serisi

<b>NEB 6500 Atc + Control Box F2067</b>	220V / 50 Hz	6,5		220	280	<b>1.588,75 €</b>	
<b>MINI NEB KIT F2037</b>	<b>Mekanik Higrostat</b>					<b>176,00 €</b>	
<b>UCV 52 F2040.1</b>	<b>Çift Motor, Nebülize, Free Cooling</b>	3-400V / 50 Hz	35	+1°C - +35°C	510	3400	<b>1.277,80 €</b>
<b>UCV 63/4 F2042.1</b>	<b>Çift Motor, Nebülize, Free Cooling</b>		35		590	7600	<b>1.352,42 €</b>
<b>AC1-80 F2001</b>	<b>Hava Kanalı, Diskli Model</b>		80		320	-	<b>762,77 €</b>
<b>AC2-160 F2002</b>	<b>Hava Kanalı, Diskli Model</b>		160		420	-	<b>1.055,96 €</b>

## AKSESUARLAR

Model	Nemlendirme Kapasitesi (lt/h)	Fiyat
<b>MT 530E</b>	Full Gauge Higrostat - Nem sensörü dahil	<b>127,90 €</b>
<b>XT110C</b>	Higrostat, 1 Röle, 4-20MA Bağlantı, Dijital Gösterge	<b>98,78 €</b>
<b>XH20P</b>	4-20 ma Bağlantı, 10...99%RH Nem Sensörü	<b>160,52 €</b>
<b>F2061</b>	NEB 6500 Donma Rezistansı	<b>93,86 €</b>
<b>F2035</b>	NEB 6500 Kontrol Panosu (Higrostat + Elektriksel Koruma Aparatları)	<b>586,07 €</b>
<b>70008</b>	NEB 6500 Elektronik Kontrol Kartı (Debi Kontrol, Drenaj, vs.)	<b>209,92 €</b>

NEB serisi nemlendiriciler soğuk odalar, depolar, seralar, filizlenme hücreleri / odaları ile fazlaca verimli ve güvenilir nemlendirme istenen her uygulama için tasarlanmıştır. Bakımı kolaydır, musluk suyu yada tamamen damıtılmış su ile çalışırlar, çok küçük bir su tankı (55 cm<sup>3</sup>) ve en özenli hijyenik kuralları takip etmek için otomatik su boşaltma sistemi vardır.

- Nemlendirme Cihazlarında Higrostat ve Nem Sensörü Fiyata Dahil Değildir.

- Kontrol Box = Neb 6500Atc Cihazı için geliştirilen Atmosferik kontrol ünitesidir.

## STAND ALONE SEUNGIL (SICAK BUHAR) NEMLENDİRİCİ

Model		Voltaj	Nemlendirme Kapasitesi (Kg/h)	Buhar Çıkış Ölçüsü (Ø / mm)	Güç Tüketimi (Kw)	Fiyat
BH004-6		220V/50Hz	4	22	3	1.236,45 \$
BH004-7		380-480V 50 Hz	4	22	3	1.236,44 \$
BH008-7			8	22	6	1.300,28 \$
BH015-7			15	22	11,3	1.385,37 \$
BH045-7			45	30	33,8	2.451,79 \$
BH030-7			30	22	22,6	Fiyat Sorunuz
BH060-7			65	45	2 x 33,8	
BH090-7			90	45	3 x 33,8	

\* SI-HUMP Kontrol cihazı fiyata dahildir.

\* Sensör, distribütör ve hortum fiyata dahil değildir.

## YEDEK PARÇA VE AKSESUARLAR

Model	Ölçü (mm)	Tip (Kg/h)		Fiyat
DİSTRÜBİTÖR SNS-230	Ø 22	4 - 6 - 8		60,06 \$
DİSTRÜBİTÖR SNS-350	Ø 30	15		69,30 \$
DİSTRÜBİTÖR SNS-450	Ø 45	45		92,40 \$
SİLİNDİR C-261		6		192,10 \$
SİLİNDİR C-383		8		192,97 \$
SİLİNDİR C-3153		15		231,24 \$
SİLİNDİR C-3453		45		672,24 \$



## OEM TYPE SEUNGIL (SICAK BUHAR) NEMLENDİRİCİ

Model	Tip	Voltaj	Nemlendirme Kapasitesi (Kg/h)	Buhar Çıkış Ölçüsü (Ø / mm)	Güç Tüketimi (Kw)	Fiyat
OH004-6	OEM	220V / 50 Hz	4	22	3	299,85 \$
OH006-7		380 - 480V / 50 Hz	4	22	3	320,80 \$
OH006-6		220V / 50 Hz	6	22	5	320,80 \$
OH008-7		380 - 480V / 50 Hz	8	22	6	320,80 \$
OH015-7		380 - 480V / 50 Hz	15	30	11,3	356,91 \$
OH045-7		380 - 480V / 50 Hz	45	45	33,8	842,11 \$

\* EM2 kontrol cihazı, nem sensörü, distribütör ve buhar hortumu fiyata dahil değildir.

Model	Tip	Voltaj	Nemlendirme Kapasitesi (Kg/h)	Buhar Çıkış Ölçüsü (Ø / mm)	Güç Tüketimi (Kw)	Fiyat
OH004-6 + EM2	OEM	220V / 50 Hz	4	22	3	459,85 \$
OH006-7 + EM2		380 - 480V / 50 Hz	4	22	3	480,80 \$
OH006-6 + EM2		220V / 50 Hz	6	22	5	480,80 \$
OH008-7 + EM2		380 - 480V / 50 Hz	8	22	6	480,80 \$
OH015-7 + EM2		380 - 480V / 50 Hz	15	30	11,3	516,91 \$
OH045-7 + EM2		380 - 480V / 50 Hz	45	45	33,8	1.002,11 \$

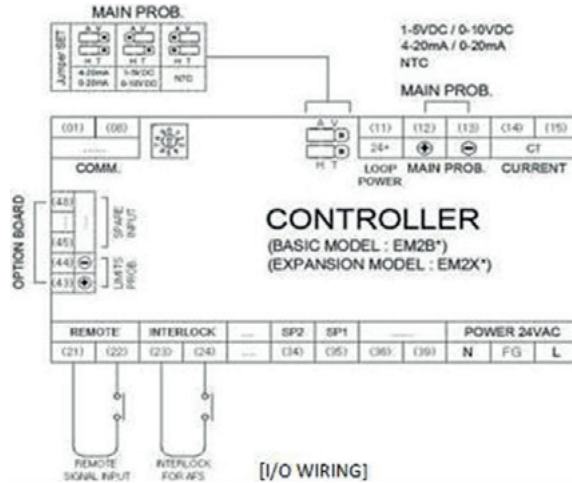

\* Nem sensörü, distribütör ve buhar hortumu fiyata dahil değildir.

Model	Voltaj	Çıkış	Haberleşme	Bağlantı	Su Boşaltma	Fiyat
EM2-B Kontrol Kartı	24V	Kontrol Röle Alarm röle	RS-485	4-20mA	Otomatik / Manuel	320,95 \$
EM2-B Ekran	12V DC					355,00 \$

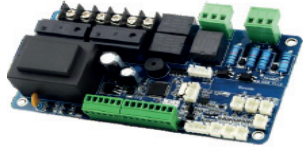

## SYSLAB PARAMETRİK KONTROL CİHAZLARI

### Endüstriyel Mini Chiller Kontrol Cihazı

Model					Fiyat
SL1506-ST	Dijital Çıkış	5	Tek ve Çift komp. kontrolü Dört yöllü vana (Elk ısıtıcı) Kondenser fan kontrolü Alarm Çıkışı Bypass Valfi Dahili faz sırası koruma Voltaj dalgalanma koruması 2HP Kompresöre kadar direk süretilme Dahili Trafo Lcd Ekran Akım kontrolü Donma Koruma Fonksiyonu	 +  SL109S (Ekran) Fiyata Dahildir.	100,08 \$
	Dijital Giriş	10			
	Analog Giriş	7			
	Besleme	220VAC			
	Bağlantı	RS485x1/SPIx1			
	Boyut	151mmx94mm			
	Terminal	Euro-plug / Terminal block			
	Akım Dedektörü	3 (harici)			
	3-Faz kontrol	Kart üzerinde			

### Aksesuarlar

NTC-10K	4,93 \$
Amper Kontrol kartı (1ad.)	5,58 \$
SYSLAB Trafo 12V 2A	25,00 \$
SYSLAB Trafo 220V-12V 1A	25,00 \$



### Fan Kontrol Cihazı (Mono Faz)

SL220ME	Çalışma Voltajı	220V±15% 50/60Hz	 IP 65	152,06 \$
	Giriş Sinyal Tipi	Basınç Transducer 0~5 Vdc NTC10K 0-10V Harici sinyal		
	Sürekli Amper	5A		

Set, diferans, sensör tipi, düz ve ters çalışma tipi, min ve max ayarları kart üzerinden yapılabilmektedir.



SL220M	Çalışma Voltajı	220V±15% 50/60Hz		89,94 \$
	Giriş Sinyal Tipi	Basınç Transducer 0~5 Vdc NTC10K 0-10V Harici sinyal		
	Sürekli Amper	5A		

### Sıcaklık ve Nem Sensörleri



SL180W	Çalışma Voltajı	12-24VDC	 CMOSens® Digital Sensing Thechnology	87,86 \$
	Giriş Sinyal Tipi	4-20mA, 0-5V, 0-10V		
	Ölçüm Aralığı	-20 / 80°C / 10 - 100% RH		
SL180D	Çalışma Voltajı	12-24VDC	 CMOSens® Digital Sensing Thechnology	115,93 \$
	Giriş Sinyal Tipi	4-20mA, 0-5V, 0-10V		
	Ölçüm Aralığı	-20 / 80°C / 10 - 100% RH		

## SYSLAB PARAMETRİK KONTROL CİHAZLARI

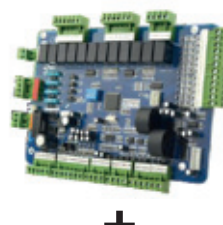

### 2 Devre Endüstriyel Chiller Kontrol Cihazı

Model	Su soğutmalı - Hava soğutmalı kondenser kontrolü			Fiyat	
SL1500-CW	Dijital Çıkış	8	2 devre kontrolü Toplam 2 kompresör 2 ad. Dört yollu vana Kondenser fan On/Off kontrol Alarm Çıkışı Bypass Valfi Dahili faz sırası koruma Voltaj dalgalanma koruması Lcd Ekran Akım kontrolü Flow swich Donma Koruma Fonksiyonu Isıtıcı / alarm çıkış Master / Slave modu	 + 	256,10 \$
	Dijital Giriş	7			
	Analog Giriş	5			
	Analog Çıkış	1			
	Besleme	12 VAC			
	Bağlantı	RS485 ModBus x 2			
	Boyut	134.0 mm x 142.0 mm			
	Terminal	Euro-plug/Terminal block			
	3-Faz kontrol	Kart üzerinde			

### 4 Devre 4 Kompresör Endüstriyel Chiller Kontrol Cihazı

Model	Su soğutmalı - Hava soğutmalı kondenser (HEAT PUMP)			Fiyat	
SL2600-MO	Dijital Çıkış	18	4ad. Kompresör 4ad. Dört yollu vana Kondenser fan On/Off kontrol 4 ad. expansion valf sürücü Alarm Çıkışı Dahili faz sırası koruma Voltaj dalgalanma koruması Akım kontrolü Lcd Ekran Flow swich Donma Koruma Fonksiyonu Isıtıcı / alarm çıkış Master / Slave modu	 + 	510,36 \$
	Dijital Giriş	21			
	Analog Giriş	18			
	Analog Çıkış	-			
	Besleme	12 VAC			
	Bağlantı	RS485 ModBus x 2			
	Boyut	267,6 mm x 135,0 mm			
	Terminal	Euro-plug/Terminal block			
	3-Faz kontrol	Kart üzerinde			

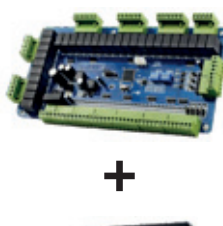
### 2 Kompresör VİDALI Endüstriyel Chiller Kontrol Cihazı

Model	ViDALI Su soğutmalı - Hava soğutmalı kondenser kontrolü			Fiyat	
SL3600-CW	Dijital Çıkış	30	Stepless, 3 Kademe veya 4 kademe step kapasite kontrol 1 ad. Dört yollu vana Alarm Kaydı Alarm Çıkışı Kompresör yağ basıncı Sıvı enjeksiyon Dokunmatik Ekran Master / Slave modu	 + 	770,99 \$
	Dijital Giriş	21			
	Analog Giriş	12			
	Analog Çıkış	0			
	Besleme	12 VAC			
	Bağlantı	RS485 ModBus x 3			
	Boyut	288 mm x 150.0 mm			
	Terminal	Euro-plug/Terminal block			
	Part-Winding ve Yıldız üçgen Çıkış.				

## SYSLAB PARAMETRİK KONTROL CİHAZLARI

### 2 Kompresör Rooftop Kontrol Cihazı

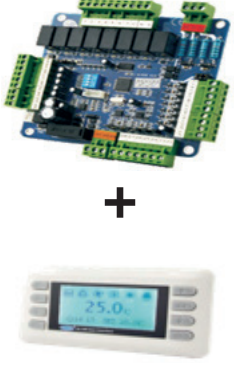
Model	Taze hava damper kontrolü			Fiyat	
SL1500-PU2	Dijital Çıkış	8	Tek kart 2 kompresör Toplam 4 kompresör 2 ad. Dört yöllü vana Toplam 4ad. dörtyollü vana Kondenser fan On/Off kontrol Alarm Çıkışı Dahili faz sırası koruma Voltaj dalgalanma koruması Lcd Ekran Isıtıcı / alarm çıkış Master / Slave modu		242,62 \$
	Dijital Giriş	7			
	Analog Giriş	5			
	Analog Çıkış	1			
	Besleme	12 VAC			
	Bağlantı	RS485 ModBus x 2			
	Boyut	134.0 mm x 142.0 mm			
	Terminal	Euro-plug/Terminal block			
	3-Faz kontrol	Kart üzerinde			

### AHU Kontrol Cihazı

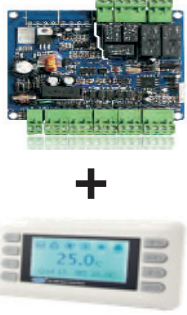
Model	Diferansiyel kontrol, PI kontrolü, orantılı entegre nem alma kontrolü			Fiyat	
SL1800-AH	Dijital Çıkış	5	1ad. Soğutma Valfi 1ad. Isıtma Valfi 2ad. Isıtıcı kontrolü Alarm Çıkışı Lcd ekran Master / Slave modu		242,62 \$
	Dijital Giriş	5			
	Analog Giriş	3			
	Analog Çıkış	-			
	Besleme	12 VAC			
	Bağlantı	RS485 ModBus x 2			
	Boyut	125,0 mm x 117,0 mm			
	Terminal	Euro-plug/Terminal block			

### 2 Adet Kompresör, 1 Adet Nemlendirici ve 2 Adet Isıtıcı AHU- AC Kontrol Cihazı

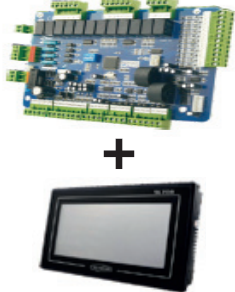
Model	Diferansiyel kontrol, PI kontrolü, orantılı entegre nem alma kontrolü			Fiyat	
SL1600F-TH3	Dijital Çıkış	12	1ad. Soğutma Valfi 1ad. Isıtma Valfi 2ad. Isıtıcı kontrolü Alarm Çıkışı Lcd ekran Master / Slave modu		943,50 \$
	Dijital Giriş	13			
	Analog Giriş	6			
	Analog Çıkış	2			
	Besleme	12 VAC			
	Bağlantı	RS485 ModBus x 3			
	Boyut	288 mm x 150.0 mm			
	Terminal	Euro-plug/Terminal block			

200 x 146 x 41,8 mm

## MATCHWELL ELEKTRONİK BASINÇ PRESOSTATLARI

Model	Uygulama Tipi	On (Bar)	Off (Bar)	Özellikler	Fiyat
V007G026G (Alçak Basınç)	Otomatik Reset	1,8	-0,5	1,5 Mt Kablolü İki Uçlu IP67 Korumalı	6,95 \$
004D026G (Alçak Basınç)	Otomatik Reset	1,8	0,3		6,95 \$
010F030G (Alçak Basınç)	Otomatik Reset	2,1	0,7		6,95 \$
025G040G (Alçak Basınç)	Otomatik Reset	2,7	1,7		6,95 \$
025G054G (Alçak Basınç)	Otomatik Reset	3,7	1,7		6,95 \$
2,3G3,5G (Alçak Basınç)	Otomatik Reset	3,5	2,3		6,95 \$
085M011M (Fan Kontrol)	Otomatik Reset	11	8,5		6,95 \$
189R261R (Fan Kontrol)	Otomatik Reset	18	13		6,95 \$
218R276R (Fan Kontrol)	Otomatik Reset	19	15		6,95 \$
232R305R (Fan Kontrol)	Otomatik Reset	21	16		6,95 \$
18R21R (Fan Kontrol)	Otomatik Reset	21	18		6,95 \$
24R29R (Fan Kontrol)	Otomatik Reset	29	24		6,95 \$
021R016R (Yüksek Basınç)	Otomatik Reset	21	16		6,95 \$
024R018R (Yüksek Basınç)	Otomatik Reset	18	24		6,95 \$
377R290R (Yüksek Basınç)	Otomatik Reset	20	26		6,95 \$
406R305R (Yüksek Basınç)	Otomatik Reset	21	28		6,95 \$
450R377R (Yüksek Basınç)	Otomatik Reset	26	31		6,95 \$
580R464R (Yüksek Basınç)	Otomatik Reset	32	40		6,95 \$
042R033R (Yüksek Basınç)	Otomatik Reset	33	42		6,95 \$

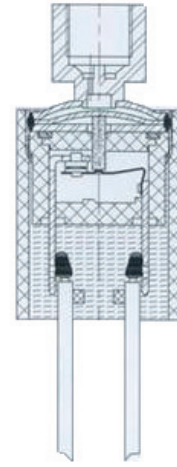

Çalışma Sıcaklığı : -50°C~+120°C

Patlama Basıncı : 5.000 PSI (345 Bar)

Elektrik Kapasitesi : (24V = 125Watt) - (120-230V = 375Watt)



## MATCHWELL FANCOIL MOTORU

Kod	Model	Paket	Fiyat
YF120-140-4A6	<b>Matchwell Fancoil Motoru</b> 140 W, 220V, 50 Hz, 3 Devir, 1040/1225/1330 rpm, Çift Milli	80	93,00 \$
	<b>FANCOIL KANADI</b> Ø14 cm Uzunluk 22,80 cm	-	15,90 \$



## KAYNAKLI GÖZETLEME CAMLARI

Model No	Kod No	Bağlantı	Özellikler	Paket	Fiyat
<b>SGN-1/4</b>	6001-00	1/4"	<ul style="list-style-type: none"> <li>• Kesin Renk Kalibrasyonu</li> <li>• Tam Sızdırmazlık ve Geniş Görüş Açığı</li> </ul> <p><b>45 Bar / 652 psi    -40°C / +80°C</b></p> 	100	<b>5,18 \$</b>
<b>SGN-3/8</b>	6002-000	3/8"		100	<b>6,55 \$</b>
<b>SGN-1/2</b>	6003-00A	1/2"		100	<b>7,06 \$</b>
<b>SGN-5/8</b>	6004-00A	5/8"		100	<b>8,79 \$</b>
<b>SGN-3/4</b>	6005-00A	3/4"		50	<b>10,83 \$</b>
<b>SGN-7/8</b>	6006-00A	7/8"		50	<b>12,74 \$</b>
<b>SGN-1 1/8</b>	6008-00	1 1/8"		40	<b>23,07 \$</b>

## RAKORLU GÖZETLEME CAMLARI

Model No	Kod No	Bağlantı	Özellikler	Paket	Fiyat
<b>SGN-1/4</b>	6011-00A	1/4"	<p><b>45 Bar / 652 psi    -40°C / +80°C</b></p> 	100	<b>4,65 \$</b>
<b>SGN-3/8</b>	6012-00A	3/8"		100	<b>5,85 \$</b>
<b>SGN-1/2</b>	6013-00A	1/2"		100	<b>6,55 \$</b>
<b>SGN-5/8</b>	6014-00A	5/8"		50	<b>8,63 \$</b>

## ERKEK-DİŞİ RAKORLU GÖZETLEME CAMLARI

Model No	Kod No	Bağlantı	Özellikler	Paket	Fiyat
<b>SGN-1/4 MF</b>	6131-00A	1/4"	<p><b>60 Bar / 870 psi    -40°C / +80°C</b></p> 	50	<b>5,98 \$</b>
<b>SGN-3/8 MF</b>	6132-00A	3/8"		50	<b>7,15 \$</b>
<b>SGN-1/2 MF</b>	6133-00A	1/2"		50	<b>7,95 \$</b>
<b>SGN-5/8 MF</b>	6134-00A	5/8"		50	<b>9,50 \$</b>

## KROM ÖRGÜLÜ ABSORBER

Model No	Kod No	Bağlantı	Maksimum Çalışma Basıncı	Özellikler	Boy (cm)	Paket	Fiyat
<b>VAFX-038</b>	7482-30A	3/8"	45 Bar		21	100	<b>8,99 \$</b>
<b>VAFX-012</b>	7483-30A	1/2"	45 Bar		23	100	<b>9,36 \$</b>
<b>VAFX-058</b>	7484-30	5/8"	45 Bar		25	100	<b>11,11 \$</b>
<b>VAFX-034</b>	7485-30	3/4"	45 Bar		26	100	<b>14,99 \$</b>
<b>VAFX-078</b>	7486-30	7/8"	45 Bar		30	100	<b>16,09 \$</b>
<b>VAFX-118</b>	7488-30	1 1/8"	45 Bar		33	50	<b>19,14 \$</b>
<b>VAFX-138</b>	7489-30	1 3/8"	42 Bar		40	30	<b>30,62 \$</b>
<b>VAFX-158</b>	7490-30	1 5/8"	30 Bar		40	20	<b>42,88 \$</b>
<b>VAFX-218</b>	7411-01	2 1/8"	25 Bar		52	10	<b>65,06 \$</b>
<b>VAFX-258</b>	7412-01	2 5/8"	20 Bar		61	6	<b>126,29 \$</b>
<b>VAFX-318</b>	7413-01	3 1/8"	20 Bar		68	4	<b>158,84 \$</b>

## HONGSEN EXPANSION VALF

Gaz Tipi	Model	Bağlantı			Paket	Fiyat
R404A	TH404 (Kaynaklı)	İç Denge	3/8" - 1/2"		45	25,15 \$
	TH404W (Kaynaklı)	Dış Denge	3/8" - 1/2"		45	26,35 \$
R404A	TH404	İç Denge	3/8" - 1/2"		45	22,75 \$
	TH404W	Dış Denge	3/8" - 1/2"		45	23,60 \$
R134A	TH134	İç Denge	3/8" - 1/2"		45	22,75 \$
	TH134W	Dış Denge	3/8" - 1/2"		45	23,60 \$
R22	TH22	İç Denge	3/8" - 1/2"		45	22,75 \$
	TH22W	Dış Denge	3/8" - 1/2"		45	23,60 \$

Orifice	Soğutma Kapasitesi (TR)			Soğutma Kapasitesi (Kw)				Paket	Fiyat
	R22	R134A	R404A	R22	R134A	R404A			
No: 1	0,7	0,5	0,45	2,5	1,8	1,6	24	4,99 \$	
No: 2	1	0,8	0,6	3,5	2,6	2,1	24		
No: 3	1,5	1,3	1,2	5,2	4,6	4,2	24		
No: 4	2,3	1,9	1,7	8	6,7	6	24		
No: 5	3	2,5	2,2	10,5	8,6	7,7	24		
No: 6	4,5	3	2,6	15,5	10,5	9,1	24		

## KÜRESEL VANALAR

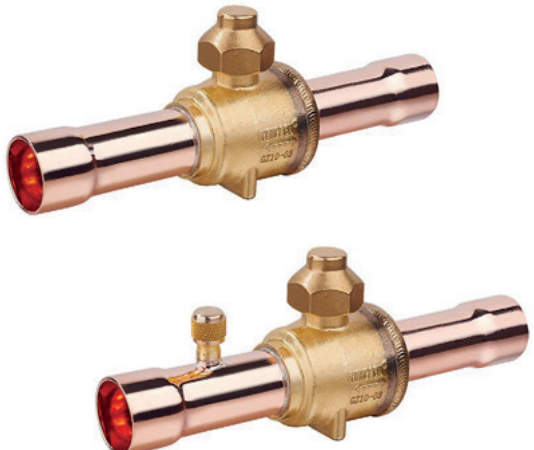
Model No	Kod No	Bağlantı	 <p>Çalışma Sıcaklığı -40°C / +150°C Maksimum Çalışma Basıncı 45 Bar Hermetik Dizayn Piringç Gövde 1/4" Subaplı Servis Portu</p>	Paket	Fiyat
GBC 6SV	7301-02S	1/4"		50	13,16 \$
GBC 10V	7302-52	3/8"		50	16,76 \$
GBC 12V	7303-52	1/2"		50	17,15 \$
GBC 16V	7304-52	5/8"		50	17,53 \$
GBC 18V	7305-82	3/4"		50	21,13 \$
GBC 22V	7306-52	7/8"		50	25,12 \$
GBC 28V	7307-52	1 1/8"		30	39,05 \$
GBC 35V	7308-52	1 3/8"		10	62,20 \$
GBC 42V	7309-52	1 5/8"		8	92,89 \$
GBC 54V	7310-52	2 1/8"		6	142,70 \$
GBC 67V	7311-52	2 5/8"		6	152,69 \$
GBC 79V	7312-52	3 1/8"		6	162,63 \$

## RAKORLU TAŞ DRIERLER

Model No	Bağlantı	Özellikler	Paket	Fiyat
DFS 032	1/4"	20 Mikrona Kadar Filtre Edebilme Özelliği Yüksek Nem ve Asit Tutma Kapasitesi	50	4,56 \$
DFS 033	3/8"		50	4,80 \$
DFS 052	1/4"		50	5,07 \$
DFS 053	3/8"		50	5,45 \$
DFS 083	3/8"		50	6,51 \$
DFS 084	1/2"		50	6,85 \$
DFS 163	3/8"		30	8,07 \$
DFS 164	1/2"		30	8,41 \$
DFS 165	5/8"		30	8,76 \$
DFS 304	1/2"		30	12,64 \$
DFS 305	5/8"		15	13,32 \$
DFS 306	3/4"		15	14,03 \$
S-164	1/2"		-	11,36 \$
S-165	5/8"		-	11,36 \$
S-305	5/8"	-	21,29 \$	



Originli Taş Drier

## KARTUŞ DRIERLER

Model No	Bağlantı	Özellikler	Paket	Fiyat
HS-D48	Kartuş Drier	Yüksek Nem ve Asit Tutucu Emme ve Basma Filtresi	12	9,47 \$
HS-F48	Kartuş Filtre		36	6,68 \$

## KARTUŞ KOVANLARI

Model No	Bağlantı	Kartuş Drayer	Özellikler	Paket	Fiyat
DFS 487S	7/8"	1	<ul style="list-style-type: none"> <li>• Optimum Akış Kapasitesi</li> <li>• Yüksek Çalışma Basıncı</li> <li>• Bakır Kaynak Bağlantı Noktası</li> </ul>	4	47,50 \$
DFS 489S	1 1/8"			4	49,25 \$
DFS 4811S	1 3/8"			4	51,10 \$
DFS 4813S	1 5/8"			4	52,25 \$
DFS 967S	7/8"	2		4	59,25 \$
DFS 969S	1 1/8"			4	61,30 \$
DFS 9611S	1 3/8"			4	63,20 \$
DFS 9613S	1 5/8"			4	65,00 \$
DFS 14413S	1 5/8"	3		2	105,00 \$
DFS 14417S	2 1/8"			2	105,00 \$



## KAYNAKLI TAŞ DRIERLER

Model No	Bağlantı	Özellikler	Paket	Fiyat
DFS 032S	1/4"	20 Mikrona Kadar Filtre Edebilme Özelliği Yüksek Nem ve Asit Tutma Kapasitesi	50	4,56 \$
DFS 033S	3/8"		50	4,90 \$
DFS 052S	1/4"		50	5,07 \$
DFS 053S	3/8"		50	5,45 \$
DFS 083S	3/8"		50	6,51 \$
DFS 084S	1/2"		50	6,85 \$
DFS 163S	3/8"		30	8,07 \$
DFS 164S	1/2"		30	8,41 \$
DFS 165S	5/8"		30	8,79 \$
DFS 304S	1/2"		30	12,64 \$
DFS 305S	5/8"		15	13,32 \$
DFS 306S	3/4"		15	14,03 \$
DFS 307S	7/8"		15	14,75 \$
DFS 309S	1 1/8"		15	16,48 \$



## ÇİFT YÖNLÜ DRIERLER

Model No	Bağlantı	Özellikler	Paket	Fiyat
BFK 083S	3/8"	Heat Pump	50	11,50 \$
BFK 084S	1/2"		50	11,80 \$
BFK 163S	3/8"		30	14,75 \$
BFK 164S	1/2"		30	14,75 \$
BFK 165S	5/8"		30	14,75 \$
BFK 305S	5/8"		15	18,50 \$
BFK 306S	3/4"		15	20,00 \$
BFK 307S	7/8"		15	21,40 \$
BFK 309S	1 1/8"		15	24,56 \$



**CHECK VALFLER**

Model No	Kod No	Bağlantı	Özellikler	Paket	Fiyat
<b>CV-6</b>	3601-00	1/4"		100	<b>6,39 \$</b>
<b>CV-10</b>	3601-00A	3/8"		100	<b>7,59 \$</b>
<b>CV-12</b>	3603-00A	1/2"		100	<b>9,37 \$</b>
<b>CV-16</b>	3604-00	5/8"		100	<b>11,96 \$</b>
<b>CV-19</b>	3605-00	3/4"		100	<b>18,73 \$</b>

Model No	Kod No	Bağlantı	Özellikler	Paket	Fiyat
<b>CV-6T</b>	3611-00	1/4"		100	<b>6,39 \$</b>
<b>CV-10T</b>	3612-00A	3/8"		100	<b>7,59 \$</b>
<b>CV-12T</b>	3613-00A	1/2"		100	<b>9,37 \$</b>
<b>CV-16T</b>	3614-00	5/8"		50	<b>11,96 \$</b>
<b>CV-19T</b>	3615-00	3/4"		50	<b>18,73 \$</b>

Model No	Kod No	Bağlantı	Özellikler	Paket	Fiyat
<b>CVR-22T</b>	3606-00	7/8"		30	<b>25,93 \$</b>
<b>CVR-28T</b>	3618-00	1 1/8"		16	<b>55,81 \$</b>
<b>CVR-35T</b>	3608-000	1 3/8"		16	<b>67,77 \$</b>
<b>CVR-42T</b>	3628-00	1 5/8"		16	<b>89,72 \$</b>

\* Çalışma basıncı 46 bar'dır

\* Çalışma aralığı -40°C / +120°C



## KAYNAKLI SOLENOID VALFLER

Model No	Kod No	Bağlantı	Özellikler	Paket	Fiyat
<b>EVR 3-2T</b>	8151-00	1/4"	 <p>-25°C / +105°C Çalışma Aralığı Normalde Kapalı Terminal Kutulu Bobin</p>	40	<b>15,13 \$</b>
<b>EVR 6-3T</b>	8161-00	3/8"		40	<b>19,12 \$</b>
<b>EVR 10-4T</b>	8171-00	1/2"		40	<b>25,93 \$</b>
<b>EVR 15-5T</b>	8181-00	5/8"		24	<b>27,91 \$</b>
<b>EVR 20-7T</b>	8185-00	7/8"		10	<b>61,81 \$</b>
<b>EVR 25-9T</b>	8188-00	1 1/8"		10	<b>77,76 \$</b>
<b>HVD 32-11T</b>	8263-00A	1 3/8"		6	<b>139,14 \$</b>
<b>HVD 40-13T</b>	8265-00A	1 5/8"		4	<b>187,75 \$</b>
<b>HVP 54</b>	8201-00	2 1/8"		4	<b>199,71 \$</b>

\* Fiyatlara bobin dahil değildir.

\* Çalışma aralığı -40°C / +105°C

## RAKORLU SOLENOID VALFLER







Model No	Kod No	Bağlantı	Özellikler	Paket	Fiyat
<b>EVR 3-3</b>	8152-00A	3/8"		40	<b>15,95 \$</b>
<b>EVR 6-4</b>	8162-00A	1/2"		40	<b>19,93 \$</b>
<b>EVR 10-5</b>	8172-00A	5/8"		40	<b>27,91 \$</b>





\* Fiyatlara bobin dahil değildir.

\* Çalışma aralığı -40°C / +105°C

## BOBİNLER

Model No	Kod No	Paket	Fiyat
<b>EVR 220 V A.C.</b>	8010-019B-220VAC	50	 <b>13,10 \$</b>
<b>EVR 12 V D.C.</b>	8010-019B-12VDC	50	
<b>EVR 24 V D.C.</b>	8010-019B-24VDC	50	
<b>EVR 24 V A.C.</b>	8010-019B-24VAC	50	
<b>EVR 110 V A.C.</b>	8010-019B-110VAC	50	
<b>EVR 380 V A.C.</b>	8010-019B-380VAC	50	

Kod No	Model No	Özellikler		Fiyat
1518H	<b>HIGH</b>	Manometre 1/8" NPT Yüksek Basınç R22 - R134a - R404A ve R407c Ø80 mm		<b>8,12 \$</b>
1518L	<b>LOW</b>	Manometre 1/8" NPT Alçak Basınç R22 - R134a - R404A ve R407c Ø80 mm		<b>8,12 \$</b>
1527H	<b>HIGH</b>	Manometre 1/8" NPT Yüksek Basınç R32 - R410a Ø80 mm		<b>8,12 \$</b>
1527L	<b>LOW</b>	Manometre 1/8" NPT Alçak Basınç R32 - R410a Ø80 mm		<b>8,12 \$</b>
191H-1534	<b>HIGH</b>	Gliserinli Flanşlı Manometre 1/4" SAE Yüksek Basınç Arka Çıkış Ø63 mm R22 - R134a R404A ve R407c		<b>13,57 \$</b>
191L-1534	<b>LOW</b>	Gliserinli Flanşlı Manometre 1/4" SAE Alçak Basınç Arka Çıkış Ø63 mm R22 - R134a - R404A ve R407c		<b>13,57 \$</b>
HS-336-4000	<b>90 cm / 36"</b>	Hortum Seti 90 cm 1/4" SAE		<b>18,01 \$</b>
HS-372-4000	<b>180 cm / 72"</b>	Hortum Seti 180 cm 1/4" SAE		<b>29,53 \$</b>
HS-396-4000	<b>250 cm / 96"</b>	Hortum Seti 250 cm 1/4" SAE		<b>35,43 \$</b>
1303	<b>180 cm / 72"</b>	Küresel Vanalı Hortum Seti 180 cm 1/4" SAE		<b>41,34 \$</b>
1422	<b>HS-T28</b>	Bakır Boru Makası 1/8" - 1 1/8" ( 3-28 mm )		<b>16,54 \$</b>
1423	<b>HS-T42</b>	Bakır Boru Makası 1/8" - 1 5/8" ( 4-42mm )		<b>31,01 \$</b>
1430	<b>HS-1430</b>	İğne Çıkartma Aparatı		<b>23,36 \$</b>
1222	<b>HS-1222</b>	Gaz Akış Kontrol Vanası 1/4"		<b>11,13 \$</b>
1223	<b>HS-1223</b>	Gaz Akış Kontrol Vanası 5/16"		

Kod No	Model No	Özellikler		Fiyat
1071	<b>HS-S60-104</b>	Manifold Set Ø80 mm Manometre Koruyuculu 1/4"-5/16" 150 cm Hortum Tk. R410a - R404a - R407c - R134a (R410a adaptörlü)		<b>80,15 \$</b>
1024	<b>HS-350A</b>	Dijital Manifold Seti 61 Farklı Gaz Seçeneği - 150 cm Hortum Tk.- 2 Ad. Isı Sensörü - 2 Ad.Oto Şarj Soketi/8"		<b>284,71 \$</b>
1025	<b>HS-S36F-410A</b>	Ø80 mm Plastik Çantalı Manifold Set Alüminyum Gövde 1/4"-5/16" 90 cm Hortum Tk. R410a - R32		<b>88,26 \$</b>
1029	<b>HS-S60-102</b>	Manifold Set Alüminyum Gövde 90 cm Hortumlu R410a - R32		<b>71,17 \$</b>
1132	<b>HS-466NAH</b>	Tekli Manifold Yüksek Basınç R410a - R22 - R134a - R404a		<b>18,00 \$</b>
1131	<b>HS-466NAL</b>	Tekli Manifold Alçak Basınç R410a - R22 - R134a - R404a		<b>18,00 \$</b>
1213	<b>HS-MH-S</b>	Yüksek Basınç Oto Şarj Soketi 1/4 SAE Kilitli Tip		<b>18,10 \$</b>
1214	<b>HS-ML-S</b>	Alçak Basınç Oto Şarj Soketi 1/4 SAE Kilitli Tip		<b>18,10 \$</b>
1207	<b>HS-MH-1234</b>	Yüksek Basınç Oto Şarj Soketi M12 x 1,5 R1234 YF Gazı için		<b>21,50 \$</b>
1208	<b>HS-ML-1234</b>	Alçak Basınç Oto Şarj Soketi M12 x 1,5 R1234 YF Gazı için		<b>21,50 \$</b>
3301-001	<b>HS-110</b>	1/4" Borulu Subap Bakır Boru Uzunluğu 90 mm Bakır Boru Et Kalınlığı 0,6 mm		<b>1,55 \$</b>
14284	<b>CT-110</b>	1/4" Subap (Borusuz)		<b>1,09 \$</b>
14285	<b>HS-110-410A</b>	1/4" Subap (Borusuz) (R410A)		<b>2,38 \$</b>











Kod	Model	Açıklama	Fiyat
101001	127	Boru Makası Mini 1/8"-5/8"	6,38 \$
101003	174	Boru Makası Mini 3/8"-1 1/8"	14,35 \$
101006	274	Boru Makası Orta 1/8"-1 1/8"	16,28 \$
101008	312	Boru Makası Büyük 1/4"-1 5/8"	18,24 \$
101009	206	Boru Makası Extra 3/8"-2 5/8"	57,45 \$
101101	PTC-01	Kılcal Boru Makası	7,98 \$
101201	127B	Yedek Boru Makası Bıçağı	1,75 \$
101202	174B	Yedek Boru Makası Bıçağı	1,75 \$
101203	274B	Yedek Boru Makası Bıçağı	1,85 \$
101204	312B	Yedek Boru Makası Bıçağı	1,85 \$
101205	206B	Yedek Boru Makası Bıçağı	5,75 \$
101206	170B	Yedek Boru Makası Bıçağı	7,98 \$
102003	808A	Torklu Havşa Takımı	104,70 \$
102007	810A	Torklu Havşa Takımı (Cırcırlı)	127,35 \$
102103	195	Havşa Takımı	32,85 \$
102104	203	Havşa Takımı 5/8"-1 1/8"	57,45 \$
102105	525	Ayarlı Havşa Takımı	35,75 \$
102161	96	Boru Şişirme Çivisi	9,58 \$
102201	275L	Şişirmeli Havşa Takımı	46,92 \$
102203	278L	Şişirmeli Havşa Takımı (Cırcırlı)	69,25 \$
102301	100B-P	Boru Şişirme Takımı	376,65 \$
102302	100B-H	Boru Şişirme Aleti	118,50 \$
102303	101HT-A	Şişirme Takımı (Hidroilk)	504,35 \$
102304	101HT-B	Şişirme Takımı (Hidroilk)	606,50 \$
102324	100B-10	Boru Şişirme Ucu 5/8"	37,35 \$
102325	100B-12	Boru Şişirme Ucu 3/4"	37,35 \$
102326	100B-14	Boru Şişirme Ucu 7/8"	37,35 \$
102328	100B-18	Boru Şişirme Ucu 1 1/8"	68,30 \$
102330	100B-22	Boru Şişirme Ucu 1 3/8"	68,30 \$
102332	100B-26	Boru Şişirme Ucu 1 5/8"	82,95 \$
102401	404L	Boru Kıvrırma Seti	179,95 \$
102441	102-04	Boru Kıvrırma Yayı 1/4"	1,21 \$
102443	102-06	Boru Kıvrırma Yayı 3/8"	1,72 \$
102444	102-08	Boru Kıvrırma Yayı 1/2"	2,55 \$
102445	102-10	Boru Kıvrırma Yayı 5/8"	3,64 \$
102446	102-12	Boru Kıvrırma Yayı 3/4"	4,15 \$
102447	102-14	Boru Kıvrırma Yayı 7/8"	5,43 \$
102451	364A-04	Boru Kıvrırma 1/4"	33,20 \$
102452	364A-05	Boru Kıvrırma 5/16"	33,20 \$
102453	364A-06	Boru Kıvrırma 3/8"	41,82 \$
102454	364A-08	Boru Kıvrırma 1/2"	51,35 \$



Kod	Model	Açıklama	Fiyat
102455	364A-10	Boru Kıvrırma 5/8"	68,63 \$
102456	364A-12	Boru Kıvrırma 3/4"	83,63 \$
102457	364A-14	Boru Kıvrırma 7/8"	103,10 \$
203032	160G	2 Yollu Manifold (150 cm Hortumlu-Plastik Çantalı)	110,44 \$
203071	4WD	4 Yollu Manifold (Plastik Çantalı)	87,78 \$
203073	5WD	5 Yollu Manifold (150 cm Hortumlu Plastik Çantalı)	239,40 \$
203074	PM-700-24	Dijital Manifold Takımı	462,84 \$
102501	633A	Tork Anahtar Takımı	79,16 \$
102411	GB-14161820	Kıvrırma Takımı (Dişli)	2.170,48 \$
102433	368-180	3'lü Boru Kıvrırma 180°	15,32 \$
102621	201	Pinch-off Pense	9,58 \$
102641	900M-B	Rakorlu Kılcal Boru 90 cm	6,38 \$
102642	1500M-B	Rakorlu Kılcal Boru 150 cm	8,94 \$
102636	341	Hırsız Vana	10,53 \$
102652	209	Çapak Temizleme	13,41 \$
102653	21	Çapak Alma	10,53 \$
102654	021B	Çapak Alma Yedek Uç	3,19 \$
102655	22	İç-Dış Çapak Alma	19,47 \$
102656	861-3	Kalem Tipi Çapak Alma	5,75 \$
102657	861-3B	Kalem Tipi Çapak Alma Yedek Uç	3,19 \$
102662	WSR-1251	Kaynak Aynası	8,94 \$
102682	CHV-01	Sibop Tornavidası	3,19 \$
102684	RI-04	Sibop İğnesi Değişirme Vanası 1/4"	35,43 \$
102685	RI-05	Sibop İğnesi Değişirme Vanası 5/16"	34,80 \$
102686	RI-04 x RI-05	Sibop İğnesi Değişirme Vanası 1/4" x 5/16"	34,80 \$
201071	VG-80	Vakum Manometresi	16,92 \$
202054	VC-02	Sibop İğnesi (HFC)	1,44 \$
102611	122	Circir Anahtarı 1/4"-3/16", 3/8"-5/16"	6,20 \$
102613	124	Circir Anahtarı Yan 1/4"-3/16", 3/8"-5/16"	7,50 \$
102615	351	Kondanser Tarağı	6,25 \$
102616	352	Kondanser Fırçası	5,15 \$
300001	DP-168	Drenaj Pompası 9.000-30.000 BTU	79,80 \$
203022	366P-3	Tekli Manifold - A.B. (R22, R134A, R404A, R410A)	31,28 \$
201031	RG2440L-80	Tekli Manometre A.B. 1/8" NPT R22 - R134a - R404A ve R407c Ø80 mm	9,90 \$
203022	366P-3	Tekli Manifold - Y.B. (R22, R134A, R404A, R410A)	31,28 \$
201032	RG2440H-80	Tekli Manometre Y.B. 1/8" NPT R22 - R134a - R404A ve R407c Ø80 mm	9,90 \$
202001	336RYB	90 cm Sarj Hortumu	25,54 \$
202002	360RYB	150 cm Sarj Hortumu	33,52 \$
202031	360RYB-410	150 cm Sarj Hortumu (R410A)	40,22 \$
202003	372RYB	180 cm Sarj Hortumu	39,58 \$
202004	396RYB	250 cm Sarj Hortumu	46,92 \$
204003	QC-L	Araç Klima Sarj Vanası A.B.	22,02 \$
204004	QC-H	Araç Klima Sarj Vanası Y.B.	22,02 \$
204005	QC-16-L	Araç Klima Sarj Vanası A.B. (R1234yf)	41,18 \$
204006	QC-16-H	Araç Klima Sarj Vanası Y.B. (R1234yf)	41,18 \$





Kod	Model	Özellikler						Fiyat	
		Maks. Akış Hızı [L/H]	Maks. Basma Yüksekliği [m]"	Maks. Emiş Yüksekliği [m]"	Ses Seviyesi [db(A)]	Maks. kW	Voltaj & Frekans		Güç Tüketimi [kW]
9005001000	Pumpkin 10 	9	10	1,5	28	10	230V, 50/60 Hz	Çalışma Esnasında: 15 Standby: 1	<b>59,00 €</b>
9006001003	EE600 	6	6	1,5	28	7,5		Çalışma Esnasında: 13 Standby: 1	<b>73,50 €</b>
9006301015	EE1000 	10	10	1,5	27	10		Çalışma Esnasında: 8 Standby: 1	<b>87,75 €</b>
9006301016	EE1800 	18	10	2,5	28	20		Çalışma Esnasında: 14 Standby: 1	<b>107,00 €</b>
112893	EE1200 	10	10	-	27	10		Çalışma Esnasında: 8 Standby: 1	<b>142,00 €</b>
9005401001	EE1650M (2L Tank) 	32	15	-	30	30		Çalışma Esnasında: 30 Standby: 2,5	<b>177,00 €</b>
9005801001	EE1750 M 	32	15	3	35	30		Çalışma Esnasında: 30 Standby: 2,5	<b>166,00 €</b>
02202	EE150 (0,7 lt Tank) 	120	1,5	-	29	10		Çalışma Esnasında: 48 Standby: 0	<b>75,80 €</b>
02210	EE 300 (1 lt Tank) 	200	4	-	30	50		Çalışma Esnasında: 65 Standby: 0	<b>69,00 €</b>
02201	EE 400 Neo (0,5 lt Tank) 	350	4	-	27	50		Çalışma Esnasında: 65 Standby: 1	<b>99,50 €</b>
9704010010	EE 900M 	6	7	2	26	7,5		Çalışma Esnasında: 10 Standby: 7,5	<b>130,00 €</b>
116585	Freezy 	20	10	-	-	12		-	<b>179,00 €</b>

## ECKERLE YEDEK PARÇA

Kod	Model	Fiyat
9704010011	Sıcaklık Sensörü (EE900M)	<b>37,50 €</b>
9001301008	Şamandıra Anahtarı (EE600, EE900M, EE1000, EE1800)	<b>37,50 €</b>
111261	Yedek Pompa ve Şamandıra Anahtarı	<b>135,50 €</b>
9001301002	Şamandıra Anahtarı (EE2000, EE1750M)	<b>37,50 €</b>
9002002204	Tüm pompalar için optik-akustik sinyal cihazı	<b>83,00 €</b>

**WENTO R134A DC 12-24 VOLT (LBP/MBP) KOMPRESÖRLER**

Model	Disp. CC (cm <sup>3</sup> )	Devir	Kapasite (Watt)	Yağ Miktarı (ml)	Voltaj	Gaz Tipi	Fiyat
<b>WD 30G</b>	3	2.000	51,6	160	12/24V DC	R134A	<b>92,35 \$</b>
		2.500	63,6				
		3.000	74,4				
		3.500	86,4				
<b>WD 35G</b>	3,5	2.000	60	160	12/24V DC	R134A	<b>110,80 \$</b>
		2.500	73				
		3.000	86				
		3.500	100				
<b>WD 65G</b>	6,5	2.000	120	160	12/24V DC	R134A	<b>162,00 \$</b>
		2.500	150				
		3.000	180				
		3.500	210				

\* Tabloda verilen değerler -23,3°C / 54,4°C şartlarında verilmiştir. (Ashrae)



**BAIXUE R134A DC 12-24 VOLT (LBP/MBP) KOMPRESÖRLER**

Model	Disp. CC (cm <sup>3</sup> )	Devir	Kapasite (Watt)	Yağ Miktarı (ml)	Voltaj	Gaz Tipi	Fiyat
<b>QDZH26D</b>	2,6	2.000	38	150	12/24V DC	R134A	<b>92,50 \$</b>
		2.500	48				
		3.000	58				
		3.500	68				
<b>QDZH36D</b>	3,6	2.000	65	150	12/24V DC	R134A	<b>135,00 \$</b>
		2.500	80				
		3.000	95				
		3.500	110				

\* Ayarlanabilir Akü Voltaj Koruması

\* Ayarlanabilir Devir Ayarı

\* Elektronik Kart Isı Koruması

\* Fan Yüksek Amper Koruması

\* Düşük Devir Koruması

\* Motor Kalkış Hatası Koruması

(Çok yüksek Basınç veya rotor kitlemesi)

Model	Disp. CC (cm <sup>3</sup> )	-23,3°C / 54,4°C			
		2000 d/dk	2500 d/dk	3000 d/dk	3500 d/dk
<b>BD35F</b>	2	33,1	41,3	44,9	49,7
<b>BD50F</b>	2,5	41,5	51,5	61,9	71,9
<b>BD80F</b>	3	-	67,8	78,3	89,16



## FULL GAUGE DÖNÜŞTÜRÜCÜ

Model	Fiyat
SITRAD INBOX VER.01 - MINI -PC C/SITRAD	483,05 €
CONV32 VER.03 - USD/RS485 DÖNÜŞTÜRÜCÜ	76,60 €
TCP-485 WIFI LOG VER.02 - SERIAL/ETHERNET DÖNÜŞTÜRÜCÜ	183,50 €
TCP-485 VER.04 - ETHERNET DÖNÜŞTÜRÜCÜ	138,15 €
EASYPROG VER.04 - PROGRAMLAMA ANAHTARI	70,10 €



## FULL GAUGE DÖNÜŞTÜRÜCÜ

Model	Fiyat
MT512E 2HP VER.13 115/230 VAC DİJİTAL KONTROL CİHAZI / PROBLU	32,75 €
TC900E LOG VER. 03 115/230 VAC DİJİTAL KONTROL CİHAZI / PROBLU	69,05 €
BC-01 BAĞLANTI KUTUSU	6,00 €
MT514E VER.02 115/230 VAC C/ALARM DİJİTAL KONTROL CİHAZI / PROBLU	38,00 €
D-CORE VER.01 85-240 VAC KONTROLCÜ	62,75 €
RCK-602 PLUS VER.01 24VAC/DC RAF KONTROL CİHAZI	412,90 €
MT530E SICAKLIK VE NEM SENSÖRÜ / PROBLU	127,90 €
MT543E 220V DİJİTAL KONTROL CİHAZI / PROBLU	76,20 €
MT543Eİ 12-24V DİJİTAL KONTROL CİHAZI / PROBLU	76,20 €
D-CORE KONTROLCÜ	62,75 €



## VALEO ARAÇ KLİMA KOMPRESÖRLERİ

Model	Tip	Voltaj	Gaz	Kayış Tipi	Süpürme Hacmi (cc.)	Bağlantı	Fiyat
<b>TM-13</b>	6 Piston	12V DC	R134A	V	131	Üst	<b>208,86 €</b>
<b>TM-15</b>	6 Piston	12V DC		V	147	Üst	<b>208,86 €</b>
<b>TM-16</b>	6 Piston	12V DC		V	163	Üst	<b>208,86 €</b>
<b>TM-16</b>	6 Piston	12V DC		T	163	Üst	<b>208,86 €</b>
<b>TM-16</b>	6 Piston	24V DC		V	163	Üst	<b>208,86 €</b>
<b>TM-16</b>	6 Piston	24V DC		V	163	Arka	<b>208,86 €</b>
<b>TM-21</b>	10 Piston	24V DC		V	215	Arka	<b>341,25 €</b>
<b>TM-21</b>	10 Piston	24V DC		V	215	Üst	<b>341,25 €</b>
<b>TM-31</b>	10 Piston	24V DC		V	313	Üst	<b>959,33 €</b>
<b>TM-43</b>	10 Piston	24V DC		V	425	Üst	<b>1.790,22 €</b>
<b>TM-55</b>	14 Piston	24V DC		V	550	Üst	<b>Fiyat Sorunuz</b>
<b>TM-65</b>	14 Piston	24V DC		V	635	Üst	

Not: TM-43, TM-55 ve TM-65 modellerimiz otobüs klimalarında kullanılan Bitzer ve Bock kompresörlerin muadili olup daha kompakt, hafif, sarsıntısız ve %75 daha az güç çeken verimli kompresörlerdir.



Model	Özellikler	Fiyat
<b>FSF50P1</b>	1" Flow Switch	<b>44,00 \$</b>

## F-GAS SOĞUTUCU FREON GAZLARI

Gaz Tipi	Açıklama	Ambalaj (Kg.)	Fiyat
R134A	Freon R134A F-Gas 12,0 Kg. (Doldurulabilir)	12	Fiyat Sorunuz
	Tekrar Doldurulabilir Silindir Tüp F-Gas		
R404A	Freon R404A F-Gas 10 Kg. (Doldurulabilir)	10	Fiyat Sorunuz
	Tekrar Doldurulabilir Silindir Tüp F-Gas		
R407C	Freon R407C F-Gas 10 Kg. (Doldurulabilir)	10	Fiyat Sorunuz
	Tekrar Doldurulabilir Silindir Tüp F-Gas		
R410A	Freon R410A F-Gas 10 Kg. (Doldurulabilir)	10	Fiyat Sorunuz
	Tekrar Doldurulabilir Silindir Tüp F-Gas		
R32	Freon R32 F-Gas 9 Kg. (Doldurulabilir)	9	Fiyat Sorunuz
	Tekrar Doldurulabilir Silindir Tüp F-Gas		
R417A	Freon R417A F-Gas 10 Kg. (Doldurulabilir)	10	Fiyat Sorunuz
	Tekrar Doldurulabilir Silindir Tüp F-Gas		
R507	Freon R507 F-Gas 10 Kg. (Doldurulabilir)	10	Fiyat Sorunuz
	Tekrar Doldurulabilir Silindir Tüp F-Gas		

Gaz Tipi	Açıklama	Ambalaj (Kg.)	Fiyat
R134A	Freon 134A F-Gas 60 Kg. (Doldurulabilir)	60	Fiyat Sorunuz
	F-Gas 42 Kg. / 60 Kg.'lık Freon Tüpü Depozitosu		
R404A	Freon R404A F-GAS 42 Kg. (Doldurulabilir)	42	Fiyat Sorunuz
	F-Gas 42 Kg. / 60 Kg.'lık Freon Tüpü Depozitosu		
R407C	Freon R407C F-GAS 10 Kg. (Doldurulabilir)	54	Fiyat Sorunuz
	F-Gas 42 Kg. / 60 Kg.'lık Freon Tüpü Depozitosu		
R410A	Freon R410A F-GAS 10 Kg. (Doldurulabilir)	48	Fiyat Sorunuz
	F-Gas 42 Kg. / 60 Kg.'lık Freon Tüpü Depozitosu		

\* Diğer özel soğutucu gaz türleri ile ilgili talepleriniz için firmamızla irtibata geçiniz.



## KOMPRESÖR YAĞLARI

Marka	Tip	Fiyat (1 Litre)	Fiyat (5 Litre)	Fiyat (20 Litre)
FRIGOIL	POE-32	19,00 €	89,00 €	329,00 €
FRIGOIL	POE-46	20,00 €	93,00 €	345,00 €
FRIGOIL	POE-55	22,00 €	103,00 €	388,00 €
FRIGOIL	POE-68	19,00 €	89,00 €	329,00 €
FRIGOIL	POE-170	23,00 €	109,00 €	415,00 €
FRIGOIL	POE-220	25,00 €	119,00 €	459,00 €







Ölçü	90° Dirsek	TE	Manson	Uzun Dirsek	45° Dirsek
1/4"	FİYAT SORUNUZ	FİYAT SORUNUZ	FİYAT SORUNUZ	FİYAT SORUNUZ	FİYAT SORUNUZ
6 mm					
8 mm-5/16"					
3/8"					
10 mm					
1/2"					
12 mm					
16 mm					
5/8" (15,87 mm)					
3/4" (19,05 mm)					
22 mm					
7/8" (22,22 mm)					
25 mm					
28 mm					
1.1/8" (28,57 mm)					
35 mm - 1.3/8"					
42 mm					
1.5/8" (41,27 mm)					
54 mm - 2.1/8"					
64 mm					
66 mm - 2.5/8"					
76 mm					
80 mm - 3.1/8"					
89 mm					
92 mm - 3.5/8"					
105 mm - 4.1/8"					
108 mm					
133 mm					
159 mm					

Yağ Tutucu	
Ölçü	Fiyat
5/8"	FİYAT SORUNUZ
3/4"	
7/8"	
1.1/8"	
1.3/8"	
1.5/8"	
2.1/8"	



Dişi Tapa	
Ölçü	Fiyat
10 mm	FİYAT SORUNUZ
12 mm	
15 mm	
16 mm	
19 mm	
22 mm	
25 mm	
28 mm	
35 mm - 1.3/8"	
42 mm	
54 mm - 2.1/8"	
66 mm - 2.5/8"	
76 mm	
80 mm - 3.1/8"	
89 mm - 3.1/8"	
92 mm - 3.5/8"	
105 mm - 4.1/8"	
108 mm	



Redüksiyon					
Ölçü	Fiyat	Ölçü	Fiyat	Ölçü	Fiyat
10 x 8	FİYAT SORUNUZ	28 x 18	FİYAT SORUNUZ	76 x 54	FİYAT SORUNUZ
12 x 8		28 x 22		76 x 54	
12 x 10		35 x 15		76 x 66	
14 x 10		35 x 18		80 x 35	
14 x 12		35 x 22		80 x 54	
15 x 10		35 x 28		80 x 66	
15 x 12		42 x 15		89 x 76	
16 x 10		42 x 18		92 x 66	
16 x 12		42 x 22		92 x 80	
16 x 14		42 x 28		105 x 54	
22 x 12		42 x 35		105 x 66	
22 x 14		54 x 22		105 x 80	
22 x 15		54 x 28		105 x 92	
22 x 16		54 x 35		108 x 54	
22 x 18		54 x 42		108 x 66	
28 x 12		66 x 35		108 x 76	
28 x 14		66 x 42		108 x 89	
28 x 15		66 x 54		133 x 108	
28 x 16		76 x 42		159 x 133	

## DIKEY LİKİT TANKLARI

Hacim (Lt)	Model	D x L (mm)	Giriş & Çıkış	NPT	Fiyat
1	VLR.A.33b.01.B1.C1	89 x 205	ODS 6 - RV-1/4	-	<b>70,00 \$</b>
2	VLR.A.33b.02.B2.C2	120 x 215	ODS 9 - RV-3/8	-	<b>83,00 \$</b>
3	VLR.A.33b.03.B2.C2	140 x 235	ODS 9 - RV-3/8	-	<b>91,00 \$</b>
4	VLR.A.33b.04.B2.C2	140 x 305	ODS 9 - RV-3/8	-	<b>105,00 \$</b>
5	VLR.A.33b.05.B2.C2	160 x 300	ODS 9 - RV-3/8	-	<b>115,00 \$</b>
6	VLR.A.33b.06.B3.C3	160 x 350	ODS 12 - RV-1/2	-	<b>123,00 \$</b>
7	VLR.A.33b.07.B3.C3	160 x 410	ODS 12 - RV-1/2	-	<b>131,00 \$</b>
8	VLR.A.33b.08.B3.C3	180 x 380	ODS 12 - RV-1/2	-	<b>145,00 \$</b>
9	VLR.A.33b.09.B3.C3	180 x 410	ODS 12 - RV-1/2	-	<b>148,00 \$</b>
10	VLR.A.33b.10.B4.C4	180 x 460	ODS 16 - RV-5/8	-	<b>162,00 \$</b>
12	VLR.A.33b.12.B4.C4.F4	220 x 360	ODS 16 - RV-5/8	1/2"	<b>195,00 \$</b>
14	VLR.A.33b.14.B4.C4.F4	220 x 410	ODS 16 - RV-5/8	1/2"	<b>205,00 \$</b>
16	VLR.A.33b.16.B4.C4.F4	220 x 480	ODS 16 - RV-5/8	1/2"	<b>230,00 \$</b>
18	VLR.A.33b.18.B4.C4.F4	220 x 540	ODS 16 - RV-5/8	1/2"	<b>245,00 \$</b>
21	VLR.A.33b.21.B5.C4.F4	220 x 625	ODS 19 - RV-5/8	1/2"	<b>260,00 \$</b>

## YATAY LİKİT TANKLARI

Hacim (Lt)	Model	D x L (mm)	Giriş & Çıkış	NPT	Fiyat
1	HLR.A.33b.01.B1.C1	89 x 190	ODS 6 - RV-1/4	-	<b>77,00 \$</b>
2	HLR.A.33b.02.B2.C2	120 x 200	ODS 9 - RV-3/8	-	<b>90,00 \$</b>
3	HLR.A.33b.03.B2.C2	140 x 220	ODS 9 - RV-3/8	-	<b>98,00 \$</b>
4	HLR.A.33b.04.B2.C2	140 x 290	ODS 9 - RV-3/8	-	<b>112,00 \$</b>
5	HLR.A.33b.05.B2.C2	160 x 290	ODS 9 - RV-3/8	-	<b>122,00 \$</b>
6	HLR.A.33b.06.B3.C3	160 x 340	ODS 12 - RV-1/2	-	<b>130,00 \$</b>
7	HLR.A.33b.07.B3.C3	160 x 400	ODS 12 - RV-1/2	-	<b>138,00 \$</b>
8	HLR.A.33b.08.B3.C3	180 x 370	ODS 12 - RV-1/2	-	<b>155,00 \$</b>
9	HLR.A.33b.09.B3.C3	180 x 400	ODS 12 - RV-1/2	-	<b>158,00 \$</b>
10	HLR.A.33b.10.B4.C4	180 x 450	ODS 16 - RV-5/8	-	<b>172,00 \$</b>
12	HLR.A.33b.12.B4.C4.F4	220 x 345	ODS 16 - RV-5/8	1/2"	<b>205,00 \$</b>
14	HLR.A.33b.14.B4.C4.F4	220 x 395	ODS 16 - RV-5/8	1/2"	<b>215,00 \$</b>
16	HLR.A.33b.16.B4.C4.F4	220 x 465	ODS 16 - RV-5/8	1/2"	<b>240,00 \$</b>
18	HLR.A.33b.18.B4.C4.F4	220 x 525	ODS 16 - RV-5/8	1/2"	<b>255,00 \$</b>
21	HLR.A.33b.21.B5.C4.F4	220 x 610	ODS 19 - RV-5/8	1/2"	<b>270,00 \$</b>



## DIKEY LİKİT TANKLARI

Hacim (Lt)	Model	D x L (mm)	Giriş & Çıkış	NPT	Fiyat
4	V5A.33b.04.A2.A2.F4	140 x 325	1" - 1"	1/2"	<b>130,00 \$</b>
5	V5A.33b.05.A2.A2.F4	140 x 395	1" - 1"	1/2"	<b>138,00 \$</b>
6	V5A.33b.06.A2.A2.F4	140 x 475	1" - 1"	1/2"	<b>148,00 \$</b>
7	V6A.33b.07.A2.A2.F4	165 x 390	1" - 1"	1/2"	<b>160,00 \$</b>
8	V6A.33b.08.A2.A2.F4	165 x 460	1" - 1"	1/2"	<b>170,00 \$</b>
9	V6A.33b.09.A2.A2.F4	165 x 510	1" - 1"	1/2"	<b>178,00 \$</b>
10	V6A.33b.10.A2.A2.F4	165 x 550	1" - 1"	1/2"	<b>193,00 \$</b>
12	V6A.33b.12.A2.A2.F4	165 x 660	1" - 1"	1/2"	<b>209,00 \$</b>
14	V6A.33b.14.A2.A2.F4	165 x 770	1" - 1"	1/2"	<b>233,00 \$</b>
16	V6A.33b.16.A2.A2.F4	165 x 870	1" - 1"	1/2"	<b>251,00 \$</b>
18	V7A.33b.18.A2.A2.F4	219 x 560	1" - 1"	1/2"	<b>305,00 \$</b>
20	V7A.33b.20.A3.A3.F4	219 x 630	1 1/4" - 1 1/4"	1/2"	<b>329,00 \$</b>
25	V7A.33b.25.A3.A3.F4	219 x 770	1 1/4" - 1 1/4"	1/2"	<b>362,00 \$</b>
30	V7A.33b.30.A3.A3.F4	219 x 910	1 1/4" - 1 1/4"	1/2"	<b>404,00 \$</b>
	V8A.33b.30.A3.A3.F4	273 x 585			<b>437,00 \$</b>
35	V7A.33b.35.A3.A3.F4	219 x 1060	1 1/4" - 1 1/4"	1/2"	<b>451,00 \$</b>
	V8A.33b.35.A3.A3.F4	273 x 685			<b>470,00 \$</b>
40	V7A.33b.40.A4.A4.F4	219 x 1210	1 3/4" - 1 3/4"	1/2"	<b>522,00 \$</b>
	V8A.33b.40.A4.A4.F4	273 x 785			<b>518,00 \$</b>
	V9A.33b.40.A4.A4.F4	324 x 560			<b>542,00 \$</b>
45	V8A.33b.45.A4.A4.F4	273 x 875			<b>595,00 \$</b>
	V9A.33b.45.A4.A4.F4	324 x 640			<b>584,00 \$</b>
50	V8A.33b.50.A4.A4.F4	273 x 975			<b>632,00 \$</b>
	V9A.33b.50.A4.A4.F4	324 x 710			<b>622,00 \$</b>
60	V8A.33b.60.A4.A4.F4	273 x 1165	1 3/4" - 1 3/4"	1/2"	<b>729,00 \$</b>
	V9A.33b.60.A4.A4.F4	324 x 850			<b>714,00 \$</b>
70	V8A.33b.70.A4.A4.F4	273 x 1355	1 3/4" - 1 3/4"	1/2"	<b>816,00 \$</b>
	V9A.33b.70.A4.A4.F4	324 x 970			<b>804,00 \$</b>
80	V8A.33b.80.A4.A4.F4	273 x 1545	1 3/4" - 1 3/4"	1/2"	<b>942,00 \$</b>
	V9A.33b.80.A4.A4.F4	324 x 1110			<b>903,00 \$</b>
90	V8A.33b.90.A4.A4.F4	273 x 1755	1 3/4" - 1 3/4"	1/2"	<b>1.041,00 \$</b>
	V9A.33b.90.A4.A4.F4	324 x 1260			<b>970,00 \$</b>
100	V9A.33b.100.A5.A5.F4	324 x 1410	2 1/4" - 2 1/4"	1/2"	<b>1.104,00 \$</b>
	V10A.33b.100.A5.A5.F4	406 x 910			<b>1.250,00 \$</b>
125	V9A.33b.125.A5.A5.F4	324 x 1710	2 1/4" - 2 1/4"	1/2"	<b>1.304,00 \$</b>
	V10A.33b.125.A5.A5.F4	406 x 1120			<b>1.435,00 \$</b>
150	V9A.33b.150.A5.A5.F4	324 x 2110	2 1/4" - 2 1/4"	1/2"	<b>1.450,00 \$</b>
	V10A.33b.150.A5.A5.F4	406 x 1340			<b>1.595,00 \$</b>
175	V10A.33b.175.A5.A5.F4	406 x 1560	2 1/4" - 2 1/4"	1/2"	<b>1.780,00 \$</b>



## EMİŞ HATTI AKÜMÜLATÖRLERİ

Hacim (Lt)	Model	D x L (mm)	Giriş & Çıkış	Isı Eşanjörü (mm)	NPT	Fiyat
1,7	SLA.33b.12.1,7	114 x 235	ODS 12 - 1/2"	-	-	76,00 \$
1,7	SLA.33b.16.1,7	114 x 235	ODS 16 - 5/8"	-	-	78,00 \$
1,7	SLA.33b.19.1,7	114 x 235	ODS 19 - 3/4"	-	-	80,00 \$
3,5	SLA.33b.22.3,5	140 x 300	ODS 22 - 7/8"	-	-	114,00 \$
5,0	SLA.33b.28.5	140 x 420	ODS 28 - 1 1/8"	-	-	140,00 \$
6,0	SLA.33b.35.6	140 x 485	ODS 35 - 1 3/8"	-	-	160,00 \$
8,1	SLA.33b.35.8,1	165 x 485	ODS 35 - 1 3/8"	-	-	182,00 \$
8,1	SLA.33b.42.8,1	165 x 490	ODS 42 - 1 5/8"	-	-	188,00 \$
9,0	SLA.33b.54.9	165 x 540	ODS 54 - 2 1/8"	-	-	226,00 \$



1,7	SLA.A.33b.12.1,7	114 x 235	ODS 12 - 1/2"	-	-	76,00 \$
1,7	SLA.A.33b.16.1,7	114 x 235	ODS 16 - 5/8"	-	-	78,00 \$
1,7	SLA.A.33b.19.1,7	114 x 235	ODS 19 - 3/4"	-	-	80,00 \$
3,5	SLA.A.33b.22.3,5	140 x 300	ODS 22 - 7/8"	-	-	114,00 \$
5,0	SLA.A.33b.28.5	140 x 420	ODS 28 - 1 1/8"	-	-	140,00 \$
6,0	SLA.A.33b.35.6	140 x 485	ODS 35 - 1 3/8"	-	-	160,00 \$
8,1	SLA.A.33b.35.8,1	165 x 485	ODS 35 - 1 3/8"	-	-	182,00 \$
8,1	SLA.A.33b.42.8,1	165 x 490	ODS 42 - 1 5/8"	-	-	188,00 \$
9,0	SLA.A.33b.54.9	165 x 540	ODS 54 - 2 1/8"	-	-	226,00 \$
13,0	SLA.A.33b.54.13	219 x 455	ODS 54 - 2 1/8"	-	-	293,00 \$
25,0	SLA.A.33b.66.25.F4	273 x 560	ODS 66 - 2 5/8"	-	1/2"	511,00 \$
32,0	SLA.A.33b.80.32.F4	324 x 520	ODS 80 - 3 1/8"	-	1/2"	670,00 \$
32,0	SLA.A.33b.92.32.F4	324 x 535	ODS 92 - 3 5/8"	-	1/2"	730,00 \$
60,0	SLA.A.33b.105.60.F4	406 x 635	ODS 105 - 4 1/8"	-	1/2"	1.370,00 \$
60,0	SLA.A.33b.109.60.F4	406 x 635	ODS 109 - 4 3/8"	-	1/2"	1.420,00 \$



## & ISI EŞANJÖRÜ

Hacim (Lt)	Model	D x L (mm)	Giriş & Çıkış	Isı Eşanjörü (mm)	NPT	Fiyat
3,5	SLA.E.33b.22.12.3,5	140 x 300	ODS 22 - 7/8"	ODS 12 - 1/2"	-	169,00 \$
5,0	SLA.E.33b.28.12.5	140 x 420	ODS 28 - 1 1/8"	ODS 12 - 1/2"	-	210,00 \$
6,0	SLA.E.33b.35.12.6	140 x 485	ODS 35 - 1 3/8"	ODS 12 - 1/2"	-	245,00 \$
8,1	SLA.E.33b.35.12.8,1	165 x 485	ODS 35 - 1 3/8"	ODS 12 - 1/2"	-	280,00 \$
8,1	SLA.E.33b.42.12.8,1	165 x 490	ODS 42 - 1 5/8"	ODS 12 - 1/2"	-	315,00 \$
9,0	SLA.E.33b.54.16.9	165 x 540	ODS 54 - 2 1/8"	ODS 16 - 5/8"	-	440,00 \$
13,0	SLA.E.33b.54.16.13	219 x 455	ODS 54 - 2 1/8"	ODS 16 - 5/8"	-	540,00 \$
32,0	SLA.E.33b.80.22.32.F4	324 x 520	ODS 80 - 3 1/8"	ODS 22 - 7/8"	1/2"	1.000,00 \$
32,0	SLA.E.33b.92.22.32.F4	324 x 535	ODS 92 - 2 5/8"	ODS 22 - 7/8"	1/2"	1.070,00 \$
60,0	SLA.E.33b.105.22.60.F4	406 x 635	ODS 105 - 4 1/8"	ODS 22 - 7/8"	1/2"	1.760,00 \$
60,0	SLA.E.33b.109.22.60.F4	406 x 635	ODS 109 - 4 3/8"	ODS 22 - 7/8"	1/2"	1.810,00 \$



## GELENEKSEL YAĞ AYIRICILAR

Model	D x L (mm)	Giriş & Çıkış	Fiyat
OS.33b.12.1	114 x 300	ODS 12 - 1/2"	144,00 \$
OS.33b.16.1	114 x 300	ODS 16 - 5/8"	146,00 \$
OS.33b.19.1	114 x 365	ODS 19 - 3/4"	160,00 \$
OS.33b.22.1	114 x 370	ODS 22 - 7/8"	171,00 \$
OS.33b.28.1	114 x 370	ODS 28 - 1 1/8"	174,00 \$
OS.33b.35.1	140 x 460	ODS 35 - 1 3/8"	215,00 \$
OS.33b.42.1	140 x 460	ODS 42 - 1 5/8"	230,00 \$
OS.33b.42.2	165 x 465	ODS 42 - 1 5/8"	258,00 \$
OS.33b.54.1	165 x 475	ODS 54 - 2 1/8"	268,00 \$
OS.33b.54.2	219 x 470	ODS 54 - 2 1/8"	340,00 \$



## YAĞ FİLTRELERİ

Model	Hacim (Lt)	D x L (mm)	Giriş & Çıkış	Gözetleme Camı	Basınç Deliği	Fiyat
OSR.33b.01	-	50 x 125	ODS 3/8" - ODS 9	-	-	46,00 \$
OSR.33b.02	-	50 x 121	SAE 3/8" - SAE 9	-	-	47,00 \$

## YAĞ SEVİYE REGÜLATÖRLERİ

Model	Hacim (Lt)	D x L (mm)	Giriş & Çıkış	Gözetleme Camı	Basınç Deliği	Fiyat
OLR.33b.01	-	102 x 156,5	SAE 3/8" - Flange	-	-	180,00 \$
OLR.33b.02	-	102 x 156,5	SAE 3/8" - Flange	2x SW36	-	229,00 \$
OLR.33b.03	-	102 x 156,5	SAE 3/8" - Flange	1x SW36	-	188,00 \$
OLR.33b.04	-	102 x 156,5	SAE 3/8" - Flange	1x SW36	-	188,00 \$

## AYARLANABİLİR YAĞ SEVİYE REGÜLATÖRLERİ

Model	Hacim (Lt)	D x L (mm)	Giriş & Çıkış	Gözetleme Camı	Basınç Deliği	Fiyat
OLR.A.33b.01	-	102 x 174,5	SAE 3/8" - Flange	-	-	196,00 \$
OLR.A.33b.02	-	102 x 174,5	SAE 3/8" - Flange	2x SW36	-	245,00 \$
OLR.A.33b.03	-	102 x 174,5	SAE 3/8" - Flange	1x SW36	-	204,00 \$
OLR.A.33b.04	-	102 x 174,5	SAE 3/8" - Flange	1x SW36	-	204,00 \$

## YAĞ DEPOLARI

Model	Hacim (Lt)	D x L (mm)	Giriş & Çıkış	Gözetleme Camı	Basınç Deliği	Fiyat
OR.33b.04	4,0	140 x 290	RV-3/8s - RV-3/8s	2x SW36	3/8" SAE Flare	253,00 \$
OR.33b.07	7,0	160 x 400				283,00 \$
OR.33b.10	10,0	180 x 450				309,00 \$
OR.33b.16	16,0	220 x 465				373,00 \$
OR.33b.18	18,0	220 x 525				390,00 \$
OR.33b.21	21,0	220 x 610				409,00 \$





**ELASTROMERİK KAUÇUK KÖPÜĞÜ LEVHALAR 120 CM**

<b>Dynaflex - Rubber SS</b>			
Kalınlık	m <sup>2</sup> / rulo	m <sup>2</sup> / Fiyat TL	Rulo / Fiyat TL
3	72	<b>68,73</b>	<b>4.948,81</b>
6	36	<b>110,10</b>	<b>3.963,76</b>
9	24	<b>147,11</b>	<b>3.530,56</b>
13	16,8	<b>211,69</b>	<b>3.556,44</b>
19	12	<b>303,50</b>	<b>3.641,98</b>
25	9,6	<b>390,24</b>	<b>3.746,29</b>
32	7,2	<b>490,86</b>	<b>3.534,19</b>
40	4,8	<b>662,49</b>	<b>3.179,95</b>
50	4,8	<b>810,60</b>	<b>3.890,87</b>

**ELASTROMERİK KAUÇUK KÖPÜĞÜ LEVHALAR 120 CM**

<b>Dynaflex - Rubber SA</b>			
Kalınlık	m <sup>2</sup> / rulo	m <sup>2</sup> / Fiyat TL	Rulo / Fiyat TL
3	72	<b>182,93</b>	<b>13.171,04</b>
6	36	<b>224,30</b>	<b>8.074,87</b>
9	24	<b>261,30</b>	<b>6.271,31</b>
13	16,8	<b>325,89</b>	<b>5.474,96</b>
19	12	<b>417,70</b>	<b>5.012,35</b>
25	9,6	<b>504,44</b>	<b>4.842,59</b>
32	7,2	<b>605,06</b>	<b>4.356,42</b>
40	4,8	<b>776,69</b>	<b>3.728,10</b>
50	4,8	<b>924,80</b>	<b>4.439,02</b>



**ELASTROMERİK KAUÇUK KÖPÜĞÜ BORULAR 200 CM**

Dynaflex - Rubber											
Boru İç Çapı			Et Kalınlığı								
Bakır	Çelik		6 mm			9 mm			13 mm		
inç	inç	Ø - mm	MT/TL	TL/KT	MT/TK	MT/TL	TL/KT	MT/TK	MT/TL	TL/KT	MT/TK
1/4"		6	6,05	3.632,52	600	10,54	4.427,43	420	18,16	4.067,86	224
5/16"		8	7,04	3.799,62	540	11,89	3.874,71	326	19,77	4.230,96	214
3/8"	1/8"	10	7,55	3.623,95	480	13,04	3.989,43	306	21,72	3.953,60	182
1/2"		12	8,70	3.132,77	360	14,34	3.843,38	268	23,47	3.943,40	168
5/8"		15	10,18	2.911,60	286	16,51	3.434,48	208	26,07	3.962,46	152
3/4"	3/8"	18	11,54	2.884,42	250	17,15	3.156,44	184	26,77	3.533,35	132
7/8"	1/2"	22	11,95	2.509,67	210	18,46	3.101,47	168	29,40	3.057,52	104
1"		25	13,50	2.375,38	176	20,30	2.679,47	132	31,67	3.167,43	100
1 1/8"	3/4"	28	14,96	2.244,66	150	22,15	2.924,41	132	35,59	2.776,18	78
1 3/8"	1"	35	18,47	2.216,43	120	26,82	2.575,13	96	41,32	2.809,43	68
1 5/8"	1 1/4"	42	20,82	2.914,34	140	30,33	2.729,68	90	48,13	2.599,11	54
	1 1/2"	48	-	-	-	34,46	2.756,79	80	53,80	2.475,00	46
2 1/8"		54	-	-	-	38,11	3.048,53	80	58,09	2.556,08	44
2 3/8"	2"	60	-	-	-	43,22	2.333,67	54	61,92	2.724,64	44
		64	-	-	-	44,99	2.429,65	54	66,28	2.518,65	38
3"	2 1/2*	76	-	-	-	53,35	2.667,57	50	74,74	2.989,53	40
3 1/8"		80	-	-	-	55,13	2.756,44	50	79,13	2.690,50	34
3 1/2"	3"	89	-	-	-	59,60	2.860,90	48	84,88	3.055,84	36
		102	-	-	-	71,30	2.281,69	32	104,08	2.914,29	28
4 1/4"		108	-	-	-	78,15	2.500,89	32	107,90	3.021,27	28
4 1/2"	4"	114	-	-	-	80,82	2.586,21	32	112,80	2.707,10	24



**ELASTROMERİK KAUÇUK KÖPÜĞÜ BORULAR 200 CM**

Dynaflex - Rubber											
Boru İç Çapı			Et Kalınlığı								
Bakır	Çelik		19 mm			25mm			32 mm		
inç	inç	Ø - mm	MT/TL	TL/KT	MT/TK	MT/TL	TL/KT	MT/TK	MT/TL	TL/KT	MT/TK
1/4"		6	-	-	-	-	-	-	-	-	-
5/16"		8	-	-	-	-	-	-	-	-	-
3/8"	1/8"	10	<b>38,16</b>	<b>3.968,22</b>	104	-	-	-	-	-	-
1/2"		12	<b>40,51</b>	<b>4.050,87</b>	100	-	-	-	-	-	-
5/8"		15	<b>45,13</b>	<b>3.610,46</b>	80	-	-	-	-	-	-
3/4"	3/8"	18	<b>45,25</b>	<b>3.257,89</b>	72	<b>68,94</b>	<b>3.860,59</b>	56	<b>97,81</b>	<b>3.325,48</b>	34
7/8"	1/2"	22	<b>47,83</b>	<b>3.157,07</b>	66	<b>75,55</b>	<b>3.777,27</b>	50	<b>105,11</b>	<b>3.363,39</b>	32
1"		25	<b>52,36</b>	<b>3.141,32</b>	60	<b>76,50</b>	<b>3.978,10</b>	52	<b>108,91</b>	<b>3.049,41</b>	28
1 1/8"	3/4"	28	<b>55,42</b>	<b>3.214,42</b>	58	<b>81,41</b>	<b>3.256,39</b>	40	<b>117,09</b>	<b>2.810,25</b>	24
1 3/8"	1"	35	<b>63,84</b>	<b>3.064,35</b>	48	<b>95,60</b>	<b>2.485,72</b>	26	<b>123,24</b>	<b>2.711,17</b>	22
1 5/8"	1 1/4"	42	<b>72,75</b>	<b>2.909,81</b>	40	<b>107,62</b>	<b>2.367,63</b>	22	<b>142,08</b>	<b>2.557,43</b>	18
	1 1/2"	48	<b>79,79</b>	<b>2.393,83</b>	30	<b>117,19</b>	<b>2.343,83</b>	20	<b>150,51</b>	<b>2.709,12</b>	18
2 1/8"		54	<b>88,86</b>	<b>2.843,43</b>	32	<b>124,11</b>	<b>2.482,25</b>	20	<b>161,99</b>	<b>2.591,91</b>	16
2 3/8"	2"	60	<b>96,92</b>	<b>2.713,69</b>	28	<b>134,88</b>	<b>2.427,83</b>	18	<b>176,16</b>	<b>2.466,17</b>	14
		64	<b>102,17</b>	<b>2.656,32</b>	26	<b>143,91</b>	<b>2.590,47</b>	18	<b>181,73</b>	<b>2.544,24</b>	14
3"	2 1/2*	76	<b>115,03</b>	<b>2.760,73</b>	24	<b>168,58</b>	<b>3.034,38</b>	18	<b>207,93</b>	<b>2.910,98</b>	14
3 1/8"		80	<b>118,32</b>	<b>2.839,78</b>	24	<b>173,65</b>	<b>3.125,79</b>	18	<b>213,85</b>	<b>2.993,96</b>	14
3 1/2"	3"	89	<b>134,96</b>	<b>2.969,20</b>	22	<b>193,95</b>	<b>2.715,24</b>	14	<b>233,97</b>	<b>2.807,65</b>	12
		102	<b>166,46</b>	<b>2.996,32</b>	18	<b>210,62</b>	<b>2.948,68</b>	14	<b>260,34</b>	<b>3.124,11</b>	12
4 1/4"		108	<b>172,28</b>	<b>3.101,06</b>	18	<b>218,24</b>	<b>3.055,32</b>	14	<b>269,22</b>	<b>3.230,70</b>	12
4 1/2"	4"	114	<b>178,10</b>	<b>3.205,79</b>	18	<b>226,10</b>	<b>3.165,33</b>	14	<b>291,15</b>	<b>2.329,21</b>	8

Dynatape Yalıtım Bantları			
Köpük Bantlar			
Ürün Adı	TL/RL	TL/RL	TL/RL
	50 mm	75 mm	100 mm
3 MM Kauçuk Bant 15 MT/RL	<b>92,59</b>	<b>138,89</b>	<b>185,19</b>



## GERİ DÖNÜŞÜM TABLOSU

Büyükük	Sembol	Gösterim			Dönüşüm
		SI	Metrik	I-P	
Güç Isı gücü	P	kJ / h kW	kcal / h	Btu / h HP	1 kW = 1 kJ/s 1 kW = 860 kcal/h 1 kW = 3415 Btu/h 1 kW = 1,341 HP 1 HP = 735,5 W 1 HP = 632 kcal/h 1 Btu/h = 0,252 kcal/h 1 kcal/h = 3,97 Btu/h
Soğutma				ton ref.	1 kW = 0,2843 tons of refrigeration 1 ton ref. = 3,517 kW 1 ton ref. = 3024 kcal/h
Enerji Isı	E, W, Q	kJ kWh	kcal	Btu	1 kWh = 3600 kJ 1 kWh = 860 kcal 1 kJ = 0,948 Btu 1 kcal = 3,97 Btu 1 kJ = 0,2388 kcal 1 kcal = 4,1868 kJ 1 Btu = 1,055 kJ 1 Btu = 0,252 kcal
Sıcaklık	T	K	°C	°F	°C = ( 0F-32 ) . 5/ 9 °F= °C. 9/ 5 +32 K = 273+°C
Hacim	V	L	L	cu in cu ft gal	1 m <sup>3</sup> = 1000 L 1 L = 61,024 cu in 1 L = 0,2642 gal 1 m <sup>3</sup> = 35,315 cu ft 1 U.S. barrel = 42 U.S.gal 1 cu in = 16,3871 cm <sup>3</sup> 1 cu ft = 0,02831 m <sup>3</sup> 1 gal = 3,78541 L
Basınç	P	Pa bar mbar N / m <sup>2</sup>	kg / cm <sup>2</sup> kg / m <sup>2</sup> mmSS atm	psi in H <sub>2</sub> O lb / ft <sub>2</sub>	1 Pa = 1 N/m <sup>2</sup> 1 bar = 100.000 Pa 1 bar = 0,987 atm 1 mbar = 10,19 mmSS 1 mmSS = 9,87 Pa 1 bar = 14,504 psi 1 mbar = 2,089 lb/ft <sub>2</sub> 1 mbar = 100 Pa 1 bar = 14,504 psi 1 kPa = 7,50062 mmHg 1 in H <sub>2</sub> O = 249,089 Pa 1 mbar = 0,4015 in H <sub>2</sub> O 1 bar = 1,02 kg/cm <sup>2</sup> 1 lb/ft <sub>2</sub> = 47,88 N/m <sup>2</sup>
Debi	V, Q	m <sup>3</sup> / s	m <sup>3</sup> / h m <sup>3</sup> / s L / s	cfm	1 m <sup>3</sup> /s = 3600 m <sup>3</sup> /h 1 m <sup>3</sup> /h = 0,5886 cfm 1 m <sup>3</sup> /h = 4,403 gal/min 1 cu ft/min = 28,3171 L/min 1 cu ft/min = 1,700 m <sup>3</sup> /h 1 gal/min = 0,272 m <sup>3</sup> /h
Uzunluk	L	m	m	in ft	1 m = 39,37 in 1 m = 3,281 ft 1 km = 0,6214 kara mili 1 km = 0,5396 deniz mili 1 in = 25,4 mm 1 ft = 30,48 cm 1 mil (kara) = 1,60934 km 1 mil (deniz) = 1,85318 km
Alan	A, F	m <sup>2</sup> m <sup>3</sup>	m <sup>2</sup> m <sup>3</sup>	sq in sq ft acre	1 m <sup>2</sup> = 1550 sq in 1 m <sup>2</sup> = 10,764 sq ft 1 ha = 10000 m <sup>2</sup> 1 ha = 2,471 acre 1 sq in = 645,16 mm <sup>2</sup> 1 sq ft = 0,0929 m <sup>2</sup> 1 acre = 0,40468 ha 1 sq mile = 2,58999 km <sup>2</sup>
Kütle	m	g kg	g kg	oz lb	1 kg = 35,274 oz 1 kg = 2,2046 lb 1 g = 15,432 grain 1 oz = 28,3495 g 1 lb = 0,4536 g 1 lb = 16 oz
Yoğunluk	d	kg / m <sup>3</sup>	kg / m <sup>3</sup>	lb / cu ft	1 kg/m <sup>3</sup> = 0,06243 lb/cuft
Hız	w, V	m / s	m / s	ft / min	1 m/s = 196,85 ft/min 1 km/h = 0,54 Kn 1 km/h = 0,6214 mph 1 ft/min = 0,508 cm/s
Özgül Isı	C, Cp	kJ / kgK	Kcal / kg °C	Btu / lb °F	1 kJ/kgK = 4,187 kcal/kg °C 1 kJ/kg0K = 0,2388 Btu/lb °F
Isı Akışı	q	kJ / m <sup>2</sup> h W / m <sup>2</sup>	kcal / m <sup>2</sup> h	Btu / hft <sub>2</sub>	1 W/ m <sup>2</sup> = 3,6 kJ/ m <sup>2</sup> h 1 W/ m <sup>2</sup> = 0,86 kcal/m <sup>2</sup> h 1 kJ/m <sup>2</sup> = 0,0881 Btu/ft <sup>2</sup> 1 W/ m <sup>2</sup> = 0,317 Btu/hft <sup>2</sup>
Isı Geçiş Katsayısı	K	W/ m <sup>2</sup> K	kcal/m <sup>2</sup> h °C	Btu/h ft <sup>2</sup> °F	1 W/ m <sup>2</sup> K = 0,1761 Btu/h ft <sup>2</sup> °F 1 W/ m <sup>2</sup> K = 0,86 kcal/m <sup>2</sup> h °C 1 Btu/h ft <sup>2</sup> °F = 5,678 W/m <sup>2</sup> K
Isı iletim Katsayısı	k	W/mK	kcal/m <sup>2</sup> h °C	Btu/h ft F	1 W/ mK = 0,578 Btu/h ft F 1 W/mK = 0,86 kcal/ mh 0C 1 Btu/h ft F = 1,7296 W/mK 1 kcal/ mh 0C = 1,162 W/mK
Isı Geçiş Direnci	1/K	m <sup>2</sup> K / W	m <sup>2</sup> h °C/ kcal	h ft <sup>2</sup> F/Btu	1 h ft <sup>2</sup> F/Btu = 0,1761 m <sup>2</sup> K/W 1 m <sup>2</sup> K / W = 1,162 m <sup>2</sup> h °C / kcal
Isı iletim Direnci	1/k				1 mK/W = 1,7296 h ft F/BTU 1 mK/W = 1,162 mh °C / kcal 1 h ft F/BTU = 0,5782 mK/W







## KREDİ KARTI İLE ÖDEME TALİMAT FORMU

Kart Sahibinin Adı			
Kart Sahibinin Soyadı			
Kart Numarası	VISA Mastercard	<input type="text"/> <input type="text"/> <input type="text"/> <input type="text"/> <input type="text"/> <input type="text"/> <input type="text"/> <input type="text"/> <input type="text"/> <input type="text"/> <input type="text"/> <input type="text"/> <input type="text"/> <input type="text"/> <input type="text"/> <input type="text"/> <input type="text"/>	
Son Kullanma Tarihi	AY	<input type="text"/> <input type="text"/>	YIL <input type="text"/> <input type="text"/> <input type="text"/> <input type="text"/> CVC <input type="text"/> <input type="text"/> <input type="text"/>

## SİPARİŞ BİLGİLERİ

Şirketinizden almış olduğum ..... (mal/ürün/hizmet cinsi tanımlanacak) karşılığında toplam ..... TL'nin (Y/..... TL, ..... KR'unun) yukarıda detayları verilen kredi kartı hesabımdan karşılanacağını, aksine hareketim halinde şirketinizin herhangi bir bildirimde bulunmaksızın ve ihtarname çekmeksizin iş bu belgeye istinaden tarafıma rücu edebileceğini kabul ve tahüt ederim.

## ÖDEME BİLGİLERİ

	GÜN	AY	YIL	TUTAR
TUTAR				..... TL

Adres	Ad, Soyad	
	Telefon No	
	Tarih	
	İmza	

DİKKAT!... Bu form ile birlikte ekte gönderilmesi zorunlu evraklar;

\* Kimlik fotokopisi

\* İmza Sirküleri

**Frigoduman**<sup>®</sup>

**FRIGODUMAN SOĞUTMA SAN. VE TİC. A.Ş.**

**İZMİR**

2818 Sokak No:24 Mersinli, KONAK – İZMİR  
Tel: 0.232.469 0 500 Faks: 0.232.449 7 833

**İSTANBUL**

Irmak Cad. No:75 Dolapdere, ŞİŞLİ – İSTANBUL  
Tel: 0.212.237 9 777 Faks: 0.212.237 9 737

**[www.frigoduman.com](http://www.frigoduman.com)**